

2009

Leaching of active ingredients from blueberries and cranberries using supercritical carbon dioxide and ethanol as an entrainer and analyzing using GC/MS

Nada H. Elsayed
University of South Florida

Follow this and additional works at: <http://scholarcommons.usf.edu/etd>

 Part of the [American Studies Commons](#)

Scholar Commons Citation

Elsayed, Nada H., "Leaching of active ingredients from blueberries and cranberries using supercritical carbon dioxide and ethanol as an entrainer and analyzing using GC/MS" (2009). *Graduate Theses and Dissertations*.
<http://scholarcommons.usf.edu/etd/1952>

This Thesis is brought to you for free and open access by the Graduate School at Scholar Commons. It has been accepted for inclusion in Graduate Theses and Dissertations by an authorized administrator of Scholar Commons. For more information, please contact scholarcommons@usf.edu.

Leaching of Active Ingredients From Blueberries and Cranberries Using Supercritical
Carbon Dioxide and Ethanol as an Entrainer and Analyzing Using GC/MS

by

Nada H. Elsayed

A thesis submitted in partial fulfillment
of the requirements for the degree of
Master of Science in Biomedical Engineering
Department of Chemical and Biomedical Engineering
College of Engineering
University of South Florida

Major Professor: Aydin K. Sunol, Ph.D.
Sermin Sunol, Ph.D.
Doug Shytle, Ph.D.

Date of Approval:
March 26, 2009

Keywords: extraction, high pressure, co-solvent, carbon dioxide, ethanol, blueberries,
cranberries

© Copyright 2009, Nada H. Elsayed

Dedication

I dedicate this work to the wonderful people in my life. To my amazing mom, Salwa who has taught me to have faith and courage and has always been my greatest supporter. To my dad, Hamdy who has always been the kindest most supportive father. Finally to the love of my life, Mostafa, who is always by my side, giving me strength, support, unconditional love and who has taught me to always be strong and stand up for my dreams. To them I truly thank from the bottom of my heart and dedicate this work.

Acknowledgments

I would like to acknowledge everyone who has helped me bring this work to a completion. I would like to give my sincere gratitude to Dr. Sunol who has always provided me with support and has guided me through the duration of this project in such a great way. Dr. Sermin who always gave me directional advice in a very calm way. Dr. Shytle for helping bring the idea for this project. Brandon Smeltzer who constantly took the time to help me improve my work by providing endless positive feedback and helpful advice, thank you for always helping me. Raquel Carvallo who was always there to offer a supporting hand and help me when I was desperate; thank you for always taking the time to help me with my setup and help me figure things out. Haitao Li (Eddie), the impossible missions' guy, who always helped me when I was stuck with equipment and pressure issues. Wade Mack and Loi Ho for kindly offering a helping hand when I needed it. Anh Tdo for always making time for my samples, running the GC/MS and helping me analyze the extracts. To the chemical engineering office staff, Carla, Cay, Sandy and Ed; thank you for constantly helping me and calming me when I thought I had missed deadlines or needed software help and was panicking.

Table of Contents

List of Tables	iii
List of Figures	iv
List of Equations	vi
Nomenclature	xi
Superscript	xvi
Subscript	xviii
Abstract	xix
Chapter 1: Introduction to Supercritical Fluids and Use of Berries as Raw Material for Medicinal Extracts	1
1.1 Production	5
Chapter 2: History and Background of Supercritical Fluids	10
2.1 The Critical State	10
2.2 Retrograde	12
2.3 Supercritical CO ₂	12
2.4 Different Methods Employing Supercritical CO ₂	13
2.5 Co-Solvents	14
2.6 Static Setup	15
2.7 Dynamic Setup	16
Chapter 3: Review of Literature Citing Extraction of Natural Components	17
Chapter 4: Fundamentals of Mass Transfer and Phase Equilibria Relating to Supercritical Fluid Extraction	29
4.1 Mass Transfer	29
4.2 Solid Extraction Using Supercritical Fluids	30
4.3 Solid-Fluid Equilibria	34
4.4 Solid-Liquid-Vapor Equilibrium	36
4.5 Flow	39
4.6 Mass Transfer Coefficients	41
4.7 Gibbs Free Energy	44

4.8	Equations of State	49
4.9	Van Der Waals	50
4.10	Peng-Robinson	51
4.11	NRTL	52
4.12	Mixing Rules	54
Chapter 5: Experimental Setups and Procedures		57
5.1	High Pressure Experimental Setup	57
5.2	Soxhlet Extraction and Experimental Setup	58
5.3	Equipment Specifications	60
5.3.1	Extraction and Collection Vessels	60
5.3.2	Temperature Controllers	60
5.3.3	Wet Test Meter	60
5.3.4	Gas Chromatograph & Mass Spectrometer	60
5.4	Experimental Procedures	61
5.4.2	Preparing the Equipment	61
5.4.3	Beginning an Experiment	62
5.4.4	Shut Down Procedure	63
5.4.5	Cleaning Procedure	64
5.4.6	Soxhlet Extraction Procedure	64
5.4.7	Soxhlet Extraction Cleaning Procedure	65
Chapter 6: Results and Discussion		66
6.1	Results	67
6.2	Discussion	84
Chapter 7: Conclusions, Recommendations and Future Directions		92
7.1	Conclusions	92
7.2	Recommendations and Future Directions	92
References		95
Appendices		99
Appendix A Tables of BB and CB Nutritional Information		100
Appendix B Sample Calculations		102
Appendix C Simplified Procedure		105

List of Tables

Table 1:	Transport Properties of Gases, Liquids and Supercritical Fluids	11
Table 2:	Significant Recent Publications Discussing Supercritical Technology	18
Table 3:	Velocity at Different Reynolds Values	41
Table 4:	Phase Effect on Velocity and Mass Transfer Coefficient	44
Table 5:	Blueberry Experimental Conditions and Corresponding Extract	67
Table 6:	Cranberry Experimental Conditions and Corresponding Extract	68
Table 7:	Blueberry and Cranberry Soxhlet Extraction Experimental Conditions and Results	69
Table 8:	Pesticides and Insecticides Extracted	90
Table 9:	Blueberry Key Nutrients	100
Table 10:	Cranberry Key Nutrients	101

List of Figures

Figure 1:	Path of β -Carotene to the Development of Vitamin A	7
Figure 2:	P-x-y diagram of CO ₂ -Ethanol	15
Figure 3:	Structure of a Plant Cell	31
Figure 4:	Total Amount of Extract With Respect to Extraction Time	32
Figure 5:	Concentration Profiles Illustrating Path of Extraction from a Solid Material	34
Figure 6:	High Pressure Experimental Setup	57
Figure 7:	Soxhlet Extraction setup	59
Figure 8:	GC of BB Sample at 125 Bars and 41.7°C	70
Figure 9:	GC of BB Sample at 124 Bars and 43.3°C	71
Figure 10:	GC of BB Sample at 126 Bars and 45.1°C	72
Figure 11:	GC of BB Sample at 127 Bars and 45.4°C	73
Figure 12:	GC of BB Sample at 125 Bars and 46.9°C	74
Figure 13:	GC of BB Sample at 197 Bars and 46.8°C	75
Figure 14:	GC of CB Sample at 125 Bars and 46.7°C	76
Figure 15:	GC of CB Sample at 122 Bars and 46.8°C	77

Figure 16:	GC of CB Sample at 125 Bars and 48.3°C	78
Figure 17:	GC of CB Sample at 123 Bars and 49.9°C	79
Figure 18:	GC of CB Sample at 194 Bars and 50.4°C	80
Figure 19:	GC of CB Sample through Soxhlet Extraction with an Ethanol Baseline	81
Figure 20:	GC of BB Sample through Soxhlet Extraction with an Ethanol Baseline	82
Figure 21:	GC of Ethanol	83
Figure 22:	β -Carotene Molecule	85
Figure 23:	Retinol Molecule	85
Figure 24:	Benzoic Acid Molecule	87
Figure 25:	Ricinoleic Acid Molecule	88
Figure 26:	Stearic Acid Molecule	88
Figure 27:	Oleic Acid Molecule	89

List of Equations

Equation 1:	Basic Mass Transfer	29
Equation 2:	Solid Solubility in Gas Phase of Supercritical Fluid	35
Equation 3:	Enhancement Factor	35
Equation 4:	Fraction of Solid Dissolved at Constant Molar Volume	36
Equation 5:	Modeling Solid-Liquid-Vapor Equilibrium from Binary Equilibrium Data	37
Equation 6:	Modeling Solid-Liquid-Vapor Equilibrium from Liquid-Vapor Equilibrium	37
Equation 7:	Modeling Solid-Liquid-Vapor Equilibrium from Solid-Liquid Equilibrium	37
Equation 8:	Liquid Phase Fugacity	37
Equation 9:	Solid Phase Fugacity	38
Equation 10:	Fugacity in Solid Phase Using an Equation of State	38
Equation 11:	Solid-Vapor Equilibrium Expression	38
Equation 12:	Mole Fraction Given a Solute in the Vapor Phase	38
Equation 13:	Reynolds Number	39
Equation 14:	Solving for Reynolds Number at a Given Velocity	41
Equation 15:	Extracted Material Per Unit Time	41

Equation 16:	Solid Phase Transportation of Extracted Substances	42
Equation 17:	Fluid Phase Transportation of Extracted Substances	42
Equation 18:	Total Resistance	42
Equation 19:	Mean Concentration	43
Equation 20:	Prandtl Number	43
Equation 21:	Nusselt Number	43
Equation 22:	Schmidt Number	43
Equation 23:	Sherwood Number	43
Equation 24:	Solving for Mass Diffusivity	44
Equation 25:	Solving for Mass Transfer Coefficient	44
Equation 26:	Gibbs Free Energy	45
Equation 27:	Single System Differential Gibbs Free Energy	45
Equation 28:	Rate of Change in Gibbs Energy with Respect to System Reaction	45
Equation 29:	Gibbs Equation for an Ideal Gas at a Pressure of 1 Bar	46
Equation 30:	Simplification of Gibbs Equation in the Differential Form	46
Equation 31:	Defining the Energy of a System μ , in Terms of Pressure	46
Equation 32:	Fugacity in Terms of μ	46

Equation 33:	Limit of Fugacity as P Approaches One	47
Equation 34:	Dimensionless Ratio of Fugacity and Pressure	47
Equation 35:	Defining Fugacity Coefficient	47
Equation 36:	Fugacity Coefficient of Pure Components	47
Equation 37:	Fugacity Coefficient for a Vapor Liquid Equilibrium of a Pure Component	47
Equation 38:	Fugacity Coefficient in Vapor Phase as it Equals that of Liquid and Saturated Phases	47
Equation 39:	Excess Function of Gibbs Energy	48
Equation 40:	Excess Energy in Terms of Activity Coefficients and Excess Volume and Enthalpy	48
Equation 41:	Excess Volume Defined in Terms of Excess Energy	48
Equation 42:	Excess Enthalpy Defined in Terms of Excess Energy	48
Equation 43:	Excess Entropy Defined in Terms of Excess Energy	48
Equation 44:	Defines Consolute Temperature	49
Equation 45:	Cubic Equation of State	50
Equation 46:	Van Der Waals Equation	50
Equation 47:	Defining Attraction Parameter	50
Equation 48:	Defining Repulsion Parameter	50
Equation 49:	Lorentz and Berthelot Mixing Rules	51

Equation 50:	Lorentz and Berthelot Mixing Rules	51
Equation 51:	Compressibility Factor	51
Equation 52:	Peng-Robinson Equation of State	51
Equation 53:	Constant a for Peng-Robinson	52
Equation 54:	Constant b for Peng-Robinson	52
Equation 55:	Correction for a at Temperatures Other than Critical	52
Equation 56:	Vapor Pressure Correlation	52
Equation 57:	Peng-Robinson Parameter a	52
Equation 58:	Peng-Robinson Parameter b	52
Equation 59:	Peng-Robinson Parameter	52
Equation 60:	Gibbs Reaction Equation for a Binary Mixture for NRTL Equation	52
Equation 61:	Gibbs Reaction Equation for a Binary Mixture for NRTL Equation	53
Equation 62:	Mole Fraction of Species 2 for NRTL Equation	53
Equation 63:	Mole Fraction of Species 1 for NRTL Equation	53
Equation 64:	Addition of Partial Molar Fractions with Respect to Species 2	53
Equation 65:	Addition of Partial Molar Fractions with Respect to Species 1	53
Equation 66:	Excess Gibbs Energy Using NRTL Equation	53

Equation 67:	NRTL Independent Parameter for Species 1	53
Equation 68:	NRTL Independent Parameter for Species 2	54
Equation 69:	Gibbs Energy for Species 1	54
Equation 70:	Gibbs Energy for Species 2	54
Equation 71:	NRTL Activity Coefficient 1	54
Equation 72:	NRTL Activity Coefficient 2	54
Equation 73:	Van Der Waals Mixing Rule for Constant a	55
Equation 74:	Van Der Waals Equation for Constant b	55
Equation 75:	Geometric-Mean Assumption	55
Equation 76:	Constant b for Wong-Sandler	56
Equation 77:	Constant a for Wong-Sandler	56

Nomenclature

a	Attraction Parameter for Van Der Waals Equation
a_i	Activity of Component i
a_{ij}	Attractive Forces Between Molecule i and Molecule j
b	Repulsion Parameter for Van Der Waals Equation
a/b	Equation of State Constants
c/d	Equation of State Constants
A	Temperature Parameter
B	Isothermal Compressibility
C	Equation of State Dependent Constant
C_p	Specific Heat at Constant Pressure
C_v	Specific Heat at Constant Volume
c_m	Mean Concentration of Extracted Components in Solid Starting Material
d	Change
D	Diameter

F	System Non-Idealities With Respect to the Fugacity Coefficient
F	Degrees of Freedom
f	Fugacity
\hat{f}	Fugacity in Solution
\bar{f}	Partial Fugacity of a Given Component in Solution
H	Enthalpy of System
H_{vap}	Heat of Vaporization
G	Gibbs Work Energy
g	Pure Substance Gibbs Energies for NRTL Equation
\hat{m}	Amount of Component Extracted
m_s	Mass of Solid Substrate
m	Number of Components in the Mixture for Van Der Waals Mixing Rules
N	Number of Equilibrium Equations/ Number of Species
n_i	Number of Moles
N_u	Nusselt Number
P	Pressure
p^S	Sublimation Pressure

P_c	Critical Pressure
P_r	Prandtl Number
R	Ideal Gas Constant
R_e	Reynolds Number
S	Entropy
S_c	Schmidt Number
S_h	Sherwood Number
T	Temperature
T^c	Consolute Temperature
T_c	Critical Temperature
V	Average Velocity
V	Volume
V^s	Molar Volume of the Solid
\bar{V}	Molar Volume
X	Species
X_i	Mole Fraction of Component i in Liquid Phase
X_2	Mole Fraction of Solute in Solution

x_i	Mole Fraction of Component i
Y	Mole Fraction in Vapor Phase
Y	Gas Phase
Z	Compressibility Factor
Z_i	Mole Fraction of Component i in Solid Phase
Δ	Change
a_{∞}^E	Excess Molar Helmholtz Energy at Infinite Pressure
α	Thermal Expansion Coefficient
α	Vapor Pressure Correlation for PR
\ln	Natural Log
ρ	Density
μ	Viscosity
μ_i	Energy of System
u	Mixture Adjustable Parameter
φ	Fugacity Coefficient
γ	Activity Coefficient
∂	Partial Differential

π	Pi
$\bar{\varphi}$	Partial Fugacity Coefficient
τ	NRTL Independent Parameter
τ	Binary Interaction Parameter
Λ	Wilson Adjustable Parameter
λ	Energy Produced Through Interaction Within Each Species and With Each Other in a Binary Mixture
ω	Accentric Factor
θ	Area Fraction
Σ	Summation

Superscript

°	Standard State
°	Temperature Degrees
+	Reference State
^	In Solution
-	Partial
α	Liquid Phase in Liquid- Liquid Equilibrium
ac	Actual
β	Liquid Phase in Liquid- Liquid Equilibrium
c	Consolute
comb	Combinatorial Energy for Gibbs
E	Excess Function
I	Component i
id	Ideal
l	Liquid Phase

resi	Residual Energy for Gibbs
s	Solid
s	Sublimation Pressure
sat	Saturated
v	Vapor Phase
x	Liquid Phase

Subscript

1	Cell Types in NRTL Equation
2	Cell Types in NRTL Equation
1	Supercritical Solvent
2	Liquid Solvent
2	Solute in Solution
3	Solid Solute
l	Number of Species
c	Critical
l	Liquid
mixt	Mixture
s	Solid
tp	Triple Point

Leaching of Active Ingredients from Blueberries and Cranberries Using Supercritical Carbon Dioxide and Ethanol as an Entrainer and Analyzing Using GC/MS

Nada H. Elsayed

ABSTRACT

Routine consumption of blueberries and cranberries has been shown to have great health benefits. Blueberries have high amounts of anthocyanin content per serving. Anthocyanins are known to be powerful antioxidants and are linked to the reduction of heart disease and cancer. New research suggests that the berries may also play a role in slowing down age related diseases such as memory loss and tissue damage caused by Alzheimer's. In addition the berries have a variety of essential vitamins and minerals that are important for overall health. Cranberries have long been used to treat urinary tract infections due to the high composition of benzoic and other acids. Both types of berries are rich in vitamin A and retinoids which have been linked to reducing certain cancers such as colon, lung and breast cancer in addition to the benefits they encompass for maintenance of eyesight. The health benefits associated with the components in the berries make them an attractive choice for extracting desirable active ingredients.

A dynamic high pressure extraction setup that consisted of an extractor and a collection vessel maintained at high pressure using back pressure regulators was built to extract active components from the berry powders using supercritical CO₂ and an entrainer (ethanol) in order to increase the solvating power of the supercritical fluid. Experiments were done at

temperatures ranging from 42°C to 50°C and pressures up to 197 bars; extracts were analyzed using a gas chromatograph coupled with a mass spectrometer (GC/MS). Successfully extracted desirable components included important vitamins such as vitamin A and biotin. Furthermore useful acids such as ricinoleic acid, palmitic acid, benzoic acid and the omega-9 acids oleic acid as well as octadecanoic acids were extracted. In addition to the desired active ingredients extracted, at the operating conditions chosen, some pesticides and insecticides that were present in the initial fruit powders were also extracted.

Chapter 1

Introduction to Supercritical Fluids and Use of Berries as Raw Materials for Medicinal Extracts

Blueberries and cranberries are gaining an appreciable amount of popularity because of the new discoveries being made that suggest all the great health benefits associated with their consumption. The berries have been found to have the highest amount of anthocyanin content per serving. Anthocyanins are known to be powerful antioxidants and are linked to the reduction of heart disease and cancer. In addition, the berries are rich in carotenoids and different vitamins such as vitamin A which has a significant role in maintaining eyesight. Recent studies suggest that blueberries may also play a role in slowing down age related diseases such as memory loss and tissue damage caused by Alzheimer's. Cranberries have also been linked to reducing instances of urinary tract infections because of the essential acids they contain. In addition the berries have a variety of essential vitamins and minerals that are important for overall health.⁴⁴

The motivation for this work was to find an effective and green way of extracting the useful, active components in blueberries and cranberries due to the recent research that suggests that blueberries and cranberries are part of the few natural foods containing high anthocyanin contents among other essential vitamins and minerals which may be linked to the reduction of heart disease and cancer with new research being done to uncover many more potential health benefits to the berries⁴⁴.

Use of supercritical fluids in industry as solvents as opposed to organic liquid solvents has been steadily increasing. As fluids are compressed beyond their critical points, their extraction power increases dramatically. Furthermore, recovery of supercritical fluids when used as solvents have been shown to be less costly and more energy efficient than liquid solvents.

Supercritical CO₂ is the most widely used supercritical fluid because it possesses many attractive features. Carbon dioxide, as a gas, is relatively safe to use since it is nonflammable and it has a low toxicity level. Carbon dioxide is not classified as a volatile organic chemical (VOC) and is therefore approved for many uses including food and drug applications. It is non-reactive by nature and is considered a green solvent. In the supercritical phase, very small temperature and pressure changes result in relatively large changes in density which then leads to favorable changes in solvent and solvating properties. Supercritical CO₂ possesses low viscosity, interfacial tension and diffuses like a gas allowing for much better mass transfer within a system as opposed to regular liquid solvents.⁵⁸

Supercritical carbon dioxide is not a very effective solvent for polar solutes unless very high pressures are used. To increase the solvating power at moderately high pressures in the supercritical phase, a small amount of a co-solvent or entrainer can be added. In the case of supercritical CO₂, entrainers include alcohols such as methanol and ethanol⁵⁸. For this work, ethanol was chosen as the co-solvent in the extraction process.

The rest of this chapter discusses pertinent aspects of blueberries and cranberries in greater details. Crop conditions as well as soil and fertilization techniques are highlighted. Finally, production statistics are included to stress the idea that awareness of the associated

health benefits and consumption are growing for the berries and are thus received by increased production.

A discussion of some of the important background concepts regarding the critical state of CO₂ as well as that of mixtures is provided in Chapter 2. The chapter also includes a discussion on the use of co-solvents, particularly ethanol and the different methods employing the use of supercritical fluids.

Relevant previously published studies that relate to this work on natural component extraction using supercritical fluid technology is included in Chapter 3. In addition, an extensive table of important publications discussing supercritical fluid technology and its uses is provided in the chapter. Finally, works that used mathematical correlations to predict solubility as well as a sampling of published material on extraction of material from natural products such as tea leaves and palm kernel oil are discussed.

A discussion of the phase equilibria concepts as they relate to this work is provided in Chapter 4. Gibbs Energy and fugacity concepts are discussed in Chapter 4 as well. Mass transfer is included in this chapter as it deals with solid starting materials and particularly plant cells. Changes in mass transfer coefficient with respect to solvent phase and flow are also provided in the same chapter. A discussion of relevant equations of state and possible mixing rules that can be used to predict solubility are included in the later part of the chapter.

Schematics of the experimental setups used for this work as well as specifications for each piece of equipment used to conduct the experiments are provided in Chapter 5. In addition, the detailed procedures used to conduct the experiments along with the shut down protocol followed are included in the same chapter.

Results obtained from the conducted experiments are discussed in Chapter 6. The corresponding gas chromatographs are included in this chapter. The detailed discussion of the findings obtained post analysis is also included in this chapter.

Suggestions that can be used to improve on the results obtained as well as the experimental procedure are provided in Chapter 7. The chapter also includes a future works section that outlines possible techniques that can be used in the future to further analyze the samples and maximize on the results.

1.1 Production

Blueberries are a member of the Plantae kingdom, family of Ericaceae in the genus Vaccinium which contains more than four hundred different berry species. Several wild types exist in North America such as highbush blueberries, rabbiteye and lowbush blueberries. They are mostly grown in the form of shrubs that are no more than a foot tall and can be found at higher elevations. Lowbush blueberries such as those used for this work are the berry choice for commerce, they grow to be about a foot in height and have a distinctly lighter blue color than other species and are mostly found in Northeastern states. Cultivation of lowbush blueberries does not require much work or time as long as weeding is done on a regular basis; then it becomes a matter of harvesting the berries. Historically, blueberry fields were burned every couple of years to control weed and insect problems but the practice is slowly being replaced with mowing techniques in order to maximize field production and life as burning caused soil oxidation. The foundation for what is now a \$300 million dollar a year industry in blueberries was established in the later 1800's by Frederick V. Coville who was able to breed large fruit cultivars.⁴⁴

USDA statistics for 2004 have shown that the United States was responsible for producing nearly half of all blueberries used worldwide; an estimated 275 million pounds which is more than a one hundred percent increase in production over a short ten year period, the numbers which continue to rise every year⁴⁴. Cultivated blueberries were responsible for most of the revenue for that year; an average of \$276 million from a total of about 45,000 acres; 30,000 of which are for lowbush blueberries. Blueberries are a relatively expensive fruit at an average of \$1.21 per pound versus other types of fruits sold per pound. This high price may be attributed to the fact that any given field must be burned down to revive plantings causing it to

be product able only once every other year. The top three blueberry growing states are Michigan, Maine and New Jersey which typically account for over sixty five percent of all US crop production. Blueberries are used in a variety of products, including baking goods, jams, juices, sweets and even some supplemental vitamins.⁴⁴

Blueberries are gaining an appreciable amount of popularity because of the new discoveries being made that suggest all the great health benefits associated with consumption of blueberries. The berries have high amounts of anthocyanin content per serving in addition to many useful vitamins and minerals such as vitamin A, β -carotene, vitamin C, various B vitamins, calcium, iron, sodium and potassium⁴⁴.

In 1987, research uncovered that the body makes use of vitamin A by having specific receptors that react to precursors of the vitamin such as the retinoids⁵. These receptors, once activated, act on regulating gene expression by targeting and binding to specific DNA sequences. Precursors of vitamin A include various carotenoids and retinal esters that are converted to retinol in the lumen of the intestine; both of which have very specific functions and uses in the body and essentially give rise to vitamin A under proper conditions in the body. Research suggests that carotenoids such as α and β - carotene have been shown to have strong antioxidant functions.⁵

The most common precursor of vitamin A is β -carotene which usually undergoes a splitting process yielding another precursor of vitamin A called retinol before vitamin A is activated as shown below in Figure 1¹⁵.

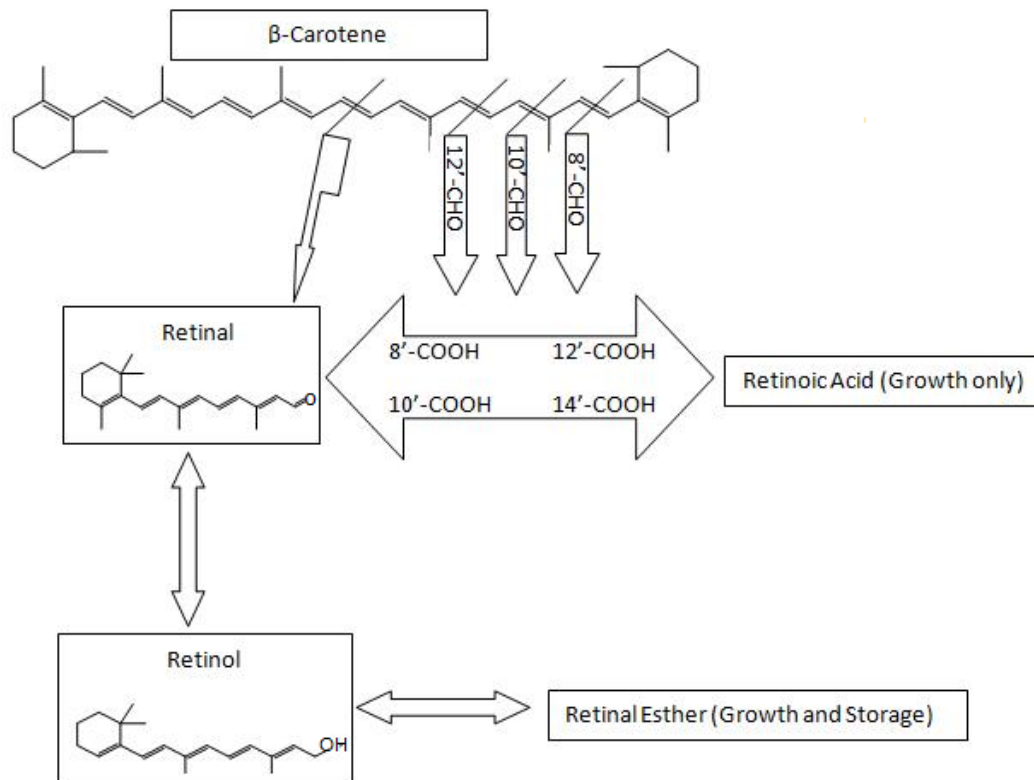

Figure 1: Path of β -Carotene to the Development of Vitamin A ¹⁵

Carotenoids such as β -carotene, shown in Figure 22 are stored in the body for various functions. For instance some β -carotene remains un-reacted in order to be used for their antioxidant functions and have also been linked to reducing chances of infections and even the development of cancer ⁵.

In addition to the role in reducing heart disease and cancer, anthocyanins are powerful antioxidants, they may also have a potential role in slowing down age related diseases such as memory loss and tissue damage caused by Alzheimer's ⁴⁴. Routine blueberry consumption has also been linked to improving vision and reducing eye sight related issues such as eye fatigue and cataracts.

Due to the growing awareness of the benefits of the berries, consequently statistics have shown that per capita consumption of blueberries has increased by more than two hundred and fifty percent in the past two and half decades bringing it to about 0.78 pounds per year. Consequently, production of blueberries has been rapidly and steadily increasing over the past decade. The total amount of land dedicated to the production of blueberries is estimated to be more than 60,000 acres in the United States alone with 30,000 acres producing lowbush blueberries.⁴⁴

Blueberries are grown in light acidic soil and are often fertilized with ammonium sulphate as opposed to nitrate nitrogen⁴⁴. The berry crop is strong enough to handle minor flooding conditions but need to be protected from drought and cold harsh conditions. The maturity of the fruit is determined by the final color as it turns from green to pink and finally to blue indicating full maturity. Since they are delicate fruits, blueberries have a shelf life of only about two weeks which is why so much of the crop is processed industrially and sold in frozen form.⁴⁴

Like blueberries, cranberries belong to the Plantae kingdom, family of Ericaceae in the genus Vaccinium with a subgenus of Oxycoccusv. Many cultivars exist, however the most popular include Early Black, Howes, Stevens and Searles. Cranberries like other types of berries have useful antioxidant power and many essential vitamins; however they have been used extensively as a treatment for urinary tract infections (UTIs) as they are rich in benzoic and quinic acid. Once inside the body these acids are easily converted to hippuric acid which is a strong antibacterial acid that helps with UTIs.⁴⁴

The United States is responsible for producing more than seventy eight percent of the world's cranberry production according to statistical data. In 2004, USDA statistics showed that

approximately 636 million pounds of cranberries were produced in just over 39,000 acres, accounting for a thirty six percent increase over the previous decade. Total production of cranberries is limited to only five states which are Wisconsin, Massachusetts, Oregon, New Jersey, and Washington. Crop revenue was down to \$222 million in 2004 from a record high of \$350 million in 1997 due to overproduction caused by improved fruit yield per acre from 1500 pounds per acre to 16000 pounds per acre. Due to overproduction, cranberries tend to be inexpensive at an average price of \$0.35 to \$0.45 per pound making it a cheap and readily available fruit. Statistics have shown that cranberry production has had an almost unfaltering increase over the past several years, making it an ideal candidate for extraction of potentially useful active ingredients.⁴⁴

In the United States alone, more than 39,000 acres are used for planting cranberries and the land dedication has been increasing steadily over the past ten years. The crop is usually flooded in order to protect the developing fruit from drought and frost. However it is a growing practice to use overhead irrigation to get the same affects as a replacement for the flooding technique.⁴⁴

Chapter 2

History and Background

This chapter will discuss some of the important background information of supercritical fluids starting from the definition of the critical state. The chapter will continue discussing some of the relevant properties of supercritical CO₂ as well as the attractive features that make it a desirable solvent to use. Co-solvents, their importance when used with supercritical fluids and how ethanol is a particularly useful co-solvent in this case will be included in this chapter. Finally the chapter will conclude with a discussion of the different experimental setups used with supercritical fluids.

2.1 The Critical State

The critical state was discovered in 1822 by Cagniard de la Tour; it is attained at certain temperatures and pressures and is defined as a state where individual gas and liquid properties change significantly in some instances by numerous orders of magnitude and become impossible to differentiate. As the critical state is approached, the density of the liquid begins to decrease while the density of the vapor increases until a single point is reached. This point at a certain pressure and temperature is called the critical point; on a phase diagram it is the point where the phase boundary disappears. The highest temperature value in which two phases, liquid and vapor can exist is known as the critical temperature. The critical pressure of a system is defined in a similar fashion as the highest pressure where two phases can coexist, above such a pressure, only one phase exists.⁵⁶

The critical state is commonly approximated by getting a series of density measurements at different conditions for both the liquid and gas phases. Initial experiments were done using sealed glass tubes and heating liquids in them and observing the resulting densities. As the critical point is reached, the boundary between both phases disappears. In the case of mixtures, critical properties of the pure components are required in order to attain a possible critical state for the mixture. As the critical point is approached both C_p and C_v increase a great deal along with the thermal conductivity, isothermal compressibility (β) and thermal expansion coefficient (α). Meanwhile, the change in heat of vaporization (ΔH_{vap}) seems to diminish as the critical point is approached along with the sonic velocity⁵⁶. Supercritical fluids when used as solvents combine the mobility of gases along with the solvating power of liquids; Table 1 outlines the transport properties for gases, liquids and supercritical fluids. It can be seen that supercritical fluids have densities closer to those of liquids but diffusivities and viscosities closer to gases.

Table 1: Transport Properties of Gases, Liquids and Supercritical Fluids⁴⁹

State	Condition	Property		
		Density, g/cm ³	Diffusivity, cm ² /s	Viscosity, g/cm-s
Gas	1 atm, 25°C	0.6-2*10 ⁻³	1-4*10 ⁻¹	1-3*10 ⁻⁴
Liquid	1 atm, 25°C	0.6-1.6	0.2-2*10 ⁻⁵	0.2-3*10 ⁻²
SC Fluid	T _c , P _c	0.2-0.5	0.5-4*10 ⁻³	1-3*10 ⁻⁴
SC Fluid	T _c , P _c	0.4-0.9	0.1-1*10 ⁻³	3-9*10 ⁻⁴

The critical state of mixtures is defined similar to pure substances when characteristics of the vapor and liquid phases are non-differentiable. Variations in the critical temperatures and

pressures highly depend on the substances in the mixtures. For similar substances, variations may be linear and it may be non-linear for dissimilar ones. For non-linear variations, there exist pressures and temperatures above the critical values of the mixture where two phases are present.⁵⁶

2.2 Retrograde

At this point, it is perhaps important to mention the retrograde phenomenon. It occurs when two phases exist above the critical temperature and pressure. This phenomenon is due to a variation in the amount of condensation or vaporization in the adverse direction of normality (normal behavior) as the pressure and temperature change.⁵⁶

2.3 Supercritical CO₂

The many attractive features possessed by supercritical CO₂ make it a very popular choice for supercritical fluid processes. Supercritical CO₂ can be used to inexpensively to fractionate, purify and isolate certain desired chemicals from starting materials. For natural products, it can also be used to remove harmful residual pesticides. Supercritical CO₂ doesn't leave residual chemicals behind, as it leaves system as a gas plus it can be recycled back into the system to cut down on cost. In addition, it is a relatively less expensive method due to the low critical temperature of 31.1°C and critical pressure of 73.8 bar associated with CO₂³⁸. In addition, carbon dioxide is not classified as a volatile organic chemical (VOC) and is therefore approved for many uses including food and drug applications. It is un-reactive by nature and is considered a green solvent. Supercritical CO₂ possesses the same attractive features as other supercritical fluids; low viscosity and interfacial tension and it has higher diffusivities similar to those of a gas allowing for much better mass transfer within a system as opposed to regular liquid solvents⁵⁸.

Supercritical CO₂ has been used extensively in the pharmaceutical industry. It is commonly used as an antisolvent for active pharmaceutical compounds by means of re-crystallization from organic solvents using such processes as gas antisolvent re-crystallization (GAS), precipitation with compressed antisolvents (PCA) and supercritical antisolvent process (SAS). In pharmaceutical practices, supercritical CO₂ is also used as a solvent to extract drug compounds without using traditional harmful solvents by means such as rapid expansion of supercritical solutions (RESS)⁴⁷. These techniques will be discussed in greater detail in the Different Methods Employing Supercritical Fluids section.

2.4 Different Methods Employing Supercritical Fluids

In 2001, Jennifer Jung and Michel Perrut²¹ published what is perhaps one of the most extensive and informative literature surveys concerning different methods for particle synthesis using supercritical fluid technology. Supercritical fluids are used as solvents for particle synthesis and encapsulation using a technique called rapid expansion of supercritical solution (RESS) which involves solubilizing the desired compound and then with the help of a nozzle, rapidly and near supersonic velocities, depressurizing the system producing very high purity particles. The limitation of the RESS method is the fact that the compound used must be soluble in the supercritical fluid due to the lack of use of other co-solvents; hence it is only useful for low polarity compound. However, as a process, RESS does not involve too many intermediate steps on a small scale since only a single nozzle is necessary to get the desired particles.²¹

Gas Anti-solvent (GAS) is a technique using supercritical fluids for re-crystallization of desired compounds through saturating an already dissolved system with a supercritical fluid thus decreasing the solvating power of the initial polar solvent and causing the particles to re-crystallize and leave the solution. In such instances, the supercritical fluid is described as being

an anti-solvent to the system and produces mostly microparticles. Supercritical fluids are used as anti-solvents in another process called supercritical anti-solvent process (SAS) which uses a spray nozzle technique to get the desired particles and sizes. Particle sizes can be controlled by changing the rate of anti-solvent introduction to the system. The GAS and SAS methods are very promising in drug delivery especially when using supercritical CO₂ as they combine the use of a stable, un-reactive solvent and allow for the active control of particle size.²¹

2.5 Co-Solvents

At certain temperatures and pressures, some substances are not soluble in supercritical fluids, for this reason the addition of a small amount of a co-solvent is useful. Co-solvents have the ability to improve the solubility of desired components in supercritical fluid as they provide the required interactions for solubilizing the desired compound⁵⁸. It was also discovered that not all co-solvents are useful for all chemical species, alcohols; specifically ethanol was determined to be a better solubilizing agent of fatty acids in supercritical CO₂ than Octane for instance³. Methanol and ethanol are two very popular choices for co-solvents as they are both soluble in supercritical CO₂; for this work, ethanol was chosen as the solvent of choice due to its high solubility in CO₂ and stability features at room temperature. The solubility of ethanol in CO₂ was done at various temperatures and pressures ranging from 18°C (291.15K) to 40°C (313.15K) and 8.6 bar (0.86 MPa) to 79.2 bar (7.92 MPa) respectively by Chany Day et al^{11,12} and the solubility data obtained was published as shown in Figure 2.

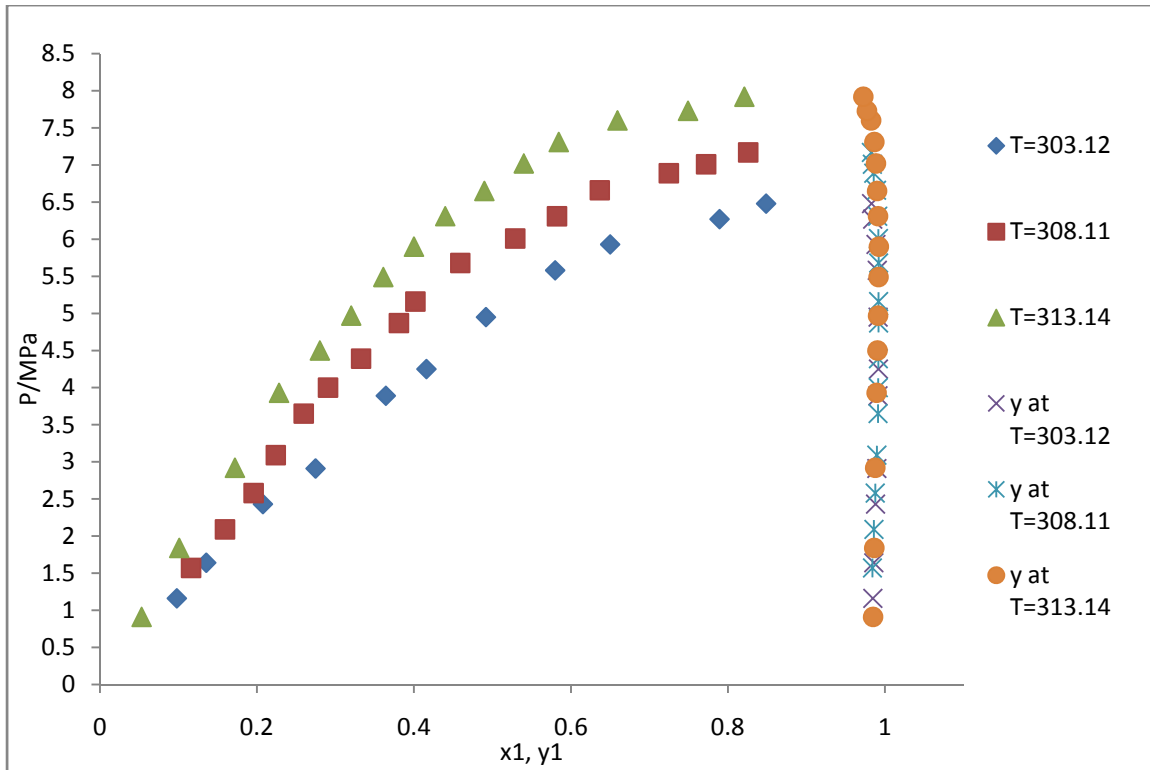

Figure 2: P-x-y Diagram of CO₂-Ethanol^{11, 12}

2.6 Static Setup

The solubility of components in a supercritical fluid can be determined using two main types of setups, a static setup or a dynamic setup. Each of the two systems has associated advantages and disadvantages. In a static setup, the main point is that there is a fixed amount of supercritical fluid introduced to the system at the desired operating conditions. In static setups, the holding cells usually have a viewing window where the sample can be observed. The main advantage of using a static setup is that the solubility of the desired component in a binary mixture can be determined without the need for sampling. Sampling can be done on multi-component mixtures easily. The system requires a minimal amount of supercritical fluid which may be a factor in cost. If two parameters are fixed such as temperature and composition then

the third parameter can be easily adjusted for a given mixture. However, static systems have the disadvantage of not being able to provide supercritical stripping data.²⁸

2.7 Dynamic Setup

Dynamic setups are characterized by having a continuous flow of supercritical fluid being constantly introduced to the system. Several advantages common to dynamic setups include the ease of having a sampling method for the desired system. Dynamic setups usually do not have viewing cells; hence any type of equipment can be used and modified. Large amounts of data can be obtained using dynamic setups versus static setups. The data obtained can be easily reproduced in a relatively short amount of time. Stripping and fractionating data as well as equilibrium data can be obtained using this type of setup. There are also several disadvantages associated with dynamic setups however. The system must be designed with extreme care to avoid depleting any of the components during a trial. Phase changes and transitions can occur undetected during an experiment. Sampling is usually done on the lighter phase which leaves the solubility in the liquid phase undetermined. Flawed solubility data can be obtained if the liquid phase is pushed out of the column; a possibility that can occur as the density of the supercritical fluid-rich phase increases which may become higher than that of the solute-containing liquid phase.²⁸

Chapter 3

Review of Literature Citing Extraction of Natural Components

This chapter will sample previously published materials that are of relevance to this work. An extensive list of relevant publications that deal with supercritical fluids and the uses for the technology published in the last two decades is included at the beginning of the chapter. The chapter will then cover different uses for supercritical fluids along with some useful correlations that have been used and published to predict solid solubility in such fluids. In addition, a sampling of some studies that were published specifically on extraction and fractionation of different berries and natural materials using supercritical fluids will also be highlighted. Finally, an important review published by Abbas et al ¹ will be highlighted that discusses the different mechanisms that can occur when extracting using supercritical fluids.

Supercritical fluid technology has been extensively researched especially in the past two decades because of all the advantages and potential uses for the technology. As a result, an endless amount of resources and publications that discuss in great detail the technology and the potential it poses for industrial applications, nutraceuticals, food technology and more are constantly being published. An extensive list of some of the important publications and compiled studies that deal with supercritical fluids is provided in Table 2 followed by a sampling of some of the recent significant supercritical extraction studies.

Table 2: Significant Recent Publications Discussing the Supercritical Technology

Publication Title	Publication Type	Author(s)/Editor(s)	Year Published	Key Factors
Supercritical Fluid Extraction ²⁸	Book	Mark McHugh Val Krukonis	1986	<ul style="list-style-type: none"> • Phase Diagrams for Supercritical Fluid-Solute Mixtures • Static and Dynamic Methods for Measuring Solubility • Phase Behavior: L-V, L-L-V, S-F • Supercritical Fluid Process Development Studies: 1976-1981 • Processing Pharmaceuticals, Natural Products, and Specialty Chemicals in SCF • High Temperature Reactions in SCF • Viscosity Effects in SCF • Enhanced Reaction Rates and Selectivities in SCF
Supercritical Fluid Chromatography and Micro-HPLC ⁵⁹	Book: Compilation of Publications	M. Yoshioka Simone Parvez	1989	<ul style="list-style-type: none"> • Sub and Supercritical Eluents in Chromatography • SCF and Packed Columns • SCF Chromatography to Conduct Oligomer Separation • Microscale SCF Extraction
Applications of Supercritical Fluids in Industrial Analysis ¹³	Book: Compilation of Publications	John R. Dean S. Hitchen	1993	<ul style="list-style-type: none"> • Properties and Fundamentals of SCF • Instruments Used for SCF Chromatography • Different Depressurization Systems • Extraction of Pharmaceuticals Via SCF Chromatography • SCF as Related to Polymer Analysis • SCF as Related to Environmental Analysis
Gas Extraction An Introduction To Fundamentals Of Supercritical Fluids And The Application To Separation	Book	G.Brunner	1994	<ul style="list-style-type: none"> • Properties of SCFs • Principle of Corresponding States • Analytical Equations of State • Diffusion in Dense Fluids • Phase Equilibria • Heat and Mass Transfer

Processes ⁶				<ul style="list-style-type: none"> • Methods for Precipitation Using Separation of Solvent and Dissolved Components • SCF Extraction from Solid Substrates • Countercurrent Extraction: Multistage
Supercritical Fluids: Fundamentals for Application ²⁴	Book: Compilation of Publications	Erdogan Kiran J. M. H. Levelt Sengers	1994	<ul style="list-style-type: none"> • Fluctuation Solutions Theory as Applied to Supercritical Conditions • Supercritical Fluid Transport Properties • SCF Microstructures • Chemistry in Supercritical Fluids • Phase Behavior of Supercritical Olefins •
High Pressure Chemical Engineering: Proceedings of the 3rd International Symposium on High Pressure Chemical Engineering, Zürich, Switzerland, October 7-9, 1996 ⁵⁵	Book: Compilation of Relevant Work	Rudolf von Rohr Ch Trepp	1996	<ul style="list-style-type: none"> • Supercritical Reaction Media to Enhance Activity of Solid Acid Catalysts • Oxidation of Organic Material in Different SCFs • Enzymatically Catalyzed Reactions in a Supercritical Medium • Different Zeolite Catalysts Under Supercritical Conditions • High Molecular Weight Alkane Mixtures Fractionated With Supercritical Fluids • Cyclic and Swing Adsorption in Supercritical Fluids
Supercritical fluid technology in oil and lipid chemistry ²³	Book	Jerry W. King Gary R. List	1996	<ul style="list-style-type: none"> • SCF Extraction of Lipids and Oilseeds • Modeling of Oilseed Solubility and Extraction • Egg Lipid Extraction Via SCF • Oleochemicals Analyzed Through SCF Chromatography
Supercritical Fluids: Extraction and Pollution Prevention ²	Book: Compilation of Relevant Work	Martin A. Abraham Aydin K. Sunol	1997	<ul style="list-style-type: none"> • Applications of Supercritical Fluid Technology • Recovery of Natural Products Using SCFs • Mass Transfer in SCFs • Potential Applications of SCFs for Environmental Clean-Up
Analytical Supercritical Fluid	Book: Compilation	E. D. Ramsey	1998	<ul style="list-style-type: none"> • Diffusion and Solvation Controlled Continuous Dynamic Supercritical Fluid Extraction

Extraction Techniques ⁴¹	of Relevant Work			<ul style="list-style-type: none"> • Supercritical Fluid Extraction On-Line and Off-Line • Sequential and Parallel SCF Extraction Systems • Liquid-Based Matrices and SCF Extraction Techniques
Chemical Synthesis Using Supercritical Fluids ²⁶	Book: Compilation of Relevant Work	Walter Leitner Philip G. Jessop	1999	<ul style="list-style-type: none"> • Introduction and Phase Behavior of SCFs • Different Extraction, Separation and Crystallization Techniques Which Utilize SCFs • Spectroscopy of SCFs
Fundamentals of Supercritical Fluids ¹⁰	Book	Tony Clifford	1999	<ul style="list-style-type: none"> • Single Components as SCFs • Non-volatile Substance Solubility in SCFs • Extraction and Transport Properties in SCFs
The Solubility of Solids in Supercritical Fluids ²⁹	Journal Article	Janette Méndez-Santiago Amy S. Teja	1999	<ul style="list-style-type: none"> • Mathematical Correlations to Predict Solid Particle Solubility in Supercritical Fluids • Predict Certain Conditions Where Solubility is Possible Without Using Too Many Properties Such as Those Required For Equations of State • Proposed Model Uses the Clausius-Clapeyron Equation to Obtain the Sublimation Pressure and Incorporates the Theory of Dilute Solutions Into A Semi-Empirical Relation to Ultimately Predict Solubility
Natural Extracts Using Supercritical Carbon Dioxide ³³	Book	Mamata Mukhopadhyaya	2000	<ul style="list-style-type: none"> • CO₂ as a SCF • Applications of SCF Technology • Solubility Behavior in SCF • Thermodynamic Modeling and Mixing Rules • Transport Fundamentals in SCF • Extraction Stages for Natural Materials • Mass and Heat Transfer in SCF • Fruit Extraction and Recovery in SCF • SCF Extraction and Fractionation of Different Spices, Herbal Extracts and Natural Antioxidants
Review: Particle Design Using Supercritical Fluids:	Journal Article	Jennifer Jung Michel Perrut	2001	<ul style="list-style-type: none"> • Different Methods for Particle Synthesis Using SCFs • Rapid Expansion of Supercritical Solution (RESS) • Re-crystallization Using Supercritical Fluids: Gas Anti-

Literature and Patent Survey ²¹				Solvent (GAS) <ul style="list-style-type: none"> • Supercritical Fluids as Anti-Solvents: Supercritical Anti-Solvent Process (SAS)
Supercritical Fluids Molecular Interactions, Physical Properties, and New Applications ³	Book	Y. Arai T. Sako Y. Takebayashi	2002	<ul style="list-style-type: none"> • Supercritical Fluids at the molecular level • Static Properties • Phase Equilibria • Transport Properties • Supercritical Fluid Extraction (Ternary Mix) • Organic and Catalytic Reactions in SC-CO₂
Supercritical Fluid Technology in Materials Science and Engineering: Syntheses, Properties, and Applications ⁴⁸	Book: Compilation of Relevant Work	Ya-Ping Sun	2002	<ul style="list-style-type: none"> • Catalysis in Supercritical Fluids • Supercritical CO₂ and In-Situ Blending of Electrically Conducting Polymers • Surfactants in SCFs • SCFs to Produce Magnetic Nanoparticles • Processing of Nanoscale Materials in SCFs
Green Chemistry Using Liquid and Supercritical Carbon Dioxide ¹⁴	Book: Compilation of Relevant Work	Joseph M. DeSimone William Tumas	2003	<ul style="list-style-type: none"> • Chemistry of Free Radicals in Supercritical CO₂ • Polymer Solubility in SC- CO₂ • Selective Hydrogenation of Fatty Acids in SCFs • Enhancement of Portland Cement Properties Using SCFs
Supercritical Carbon Dioxide Extraction of Selected Medicinal Plants-- Effects of High Pressure and Added Ethanol on Yield of Extracted Substances ¹⁹		M. Hamburger D. Baumann S. Adler	2004	<ul style="list-style-type: none"> • Supercritical Extraction of Chemicals From Marigold, Hawthorn and Chamomile Herbs • Comparison of Composition of Extractables Obtained at Very High Pressures Using Supercritical CO₂ With and Without an Ethanol Co-Solvent • Determining the Effect of Using Different Compositions of the Co-Solvent • The Experiments Were Done at Pressure of 300 to 689 Bar and Using 0 to 20% Proportions of Ethanol and a Steady Temperature of 50°C • Sample Analysis Using GC-MS and HPLC-PAD-MS
Supercritical fluids	Book	Gerd Brunner	2004	<ul style="list-style-type: none"> • Supercritical Fluid Technology in Germany

as solvents and reaction media ⁷				<ul style="list-style-type: none"> • Fundamentals of SCF • Pre-dependance of Molecular Mobility in SCF
Supercritical Fluid Technology for Drug Product Development ⁵⁸	Book: Compilation of Publications	Peter York Uday B. Kompella Boris Y. Shekunov	2004	<ul style="list-style-type: none"> • Chemistry and Materials Design for CO₂ Processing • Fluid Dynamics, Mass Transfer, and Particle Formation in Supercritical Fluids • Colloid and Interface Science for CO₂-Based Pharmaceutical Processes • Development and Potential of Critical Fluid Technology • Scale-Up Issues for Supercritical Fluid Processing in Compliance with GMP
Supercritical Carbon Dioxide (SC-CO ₂) Extraction and Fractionation of Palm Kernal Oil From Palm Kernal as Coca Butter Replacers Blend ⁶⁰	Journal Article	Zaidul, I. S., N. A. Nik Norulaini, A. K. Mohd Omar, and R. L. Smith Jr.	2006	<ul style="list-style-type: none"> • Extraction and Fractionation of Palm Kernel Oil From Palm Kernel Using Supercritical CO₂ • Operating Conditions Used Included Pressures That Ranged From 20.7 Mpa to 48.3 Mpa at Temperatures That Were Between 40 and 80°C. • High Pressure Samples Were Compared to Those Obtained Using a Traditional Soxhlet Extraction Technique • Attempt to Find Alternatives to Using Cocoa Butter in The Food Industry • Analysis Done Using Gas Chromatography (GC) and Pulsed Nuclear Magnetic Resonance (PNMR) to Determine the Solid Fat Content of the Extractables
GC/MS Characterization of Mate Tea Leaves Extracts Obtained From High-Pressure CO ₂ Extraction ²⁰	Journal Article	R. A. Jacques J. G. Santos C. Dariva J. Vladimir Oliveira E. B. Caramão.	2007	<ul style="list-style-type: none"> • Extractables Obtained From Mate Tea Leaves (Ilex Paraguariensis) Using Supercritical CO₂ • The Extracts Were Analyzed With the Assistance of Gas Chromatography Coupled With Mass Spectrometry (GC/MS) • Successful Identification of 51 Different Compounds Based on the Peaks Obtained From the Chromatograms • The Compounds Identified Included Several Esters,

				Fatty Acids and Vitamins
Optimization of Supercritical Carbon Dioxide Extraction of Sea Buckthorn (<i>Hippophaë thamnoides</i> L.) Oil Using Response Surface Methodology ⁵⁷	Journal Article	Xiang Xu Yanxiang Gao Guangmin Liu Qi Wang Jian Zhao	2007	<ul style="list-style-type: none"> • Optimization of SCF Extraction Conditions using response surface methodology (RSM) • Analysis of Response Surfaces • Experimental Results at Various Pressures and Temperatures
Solubility in supercritical carbon dioxide ¹⁸	Book	Ram B. Gupta Jae-Jin Shim	2007	<ul style="list-style-type: none"> • A Comprehensive List of Solubility Data of Different Compounds such as Oils, Acids, Tocopherols and More
Supercritical Fluid Extraction of Nutraceuticals and Bioactive Compounds ²⁷	Book: Compilation of Publications	José Luis Martinez	2007	<ul style="list-style-type: none"> • Supercritical Extraction of Different Plants • Supercritical Extraction of Specialty Oils and Tocopherols • Extraction of Active Components from Algae Using SCF • SCF Extraction of Antioxidants • SCF Extraction of Fish and Other Essential Oils
A Review of Supercritical Fluid Extraction as New Analytical Method ¹	Journal Article	K. A. Abbas A. Mohamed A. S. Abdulamir H. A. Abas	2008	<ul style="list-style-type: none"> • Advantages of Using Supercritical CO₂ in The Food Industry • Four Different Types of Extraction Mechanisms • Simple Dissolution Extraction Mechanism • Desorption and Adsorption • Swelling • Reactive Extraction
Diffusion Coefficients of Solids in Supercritical Carbon Dioxide: Modelling of Near Critical	Journal Article	Isabelle Raspo Christophe Nicolas Evelyne Neau Sofiane Meradji	2008	<ul style="list-style-type: none"> • Concentration Dependence of Diffusion Coefficients • Diffusion Coefficients of Different Binary Mixtures in Supercritical CO₂ • Modified Darken Equation

Behaviour ⁴²				
Extraction of Phenolic Compounds from Elder Berry and Different Grape Marc Varieties Using Organic Solvents and / or Supercritical Carbon Dioxide ⁵²	Journal Article	Tünde Vatai Mojca Škerget Željko Knez	2008	<ul style="list-style-type: none"> • Extract of Phenols, Flavonoids, Anthocyanins from Berries • Effect of Operating Conditions on Extract Yields • Use of Different Co-solvents with SC-CO₂ • Optical Spectroscopy and Other Analytical Techniques

In 2007, Xiang et al⁵⁷ published an interesting study on optimizing extract materials from a type of berries called sea buckthorn (*Hippophaë thamnoides* L.) under supercritical carbon dioxide using response surface methodology (RSM). Supercritical extractions were done on the seeds at pressures ranging from 12.8 to 47.2 MPa and temperatures up to 67.2°C. The extract obtained according to the study included different oils, vitamin E and carotenoids. The effects of operating conditions such as temperature, pressure and flow rate were analyzed by RSM to determine the optimum conditions for extracting from the berries. The model predicted optimum conditions to be at a pressure of 27.4 Mpa coupled with a temperature of 34.5°C and a flow rate of 17 L/hr. The significance of this study lies in the modeling aspect, given that the model successfully predicted optimum extraction conditions for the berries used for the study, indicates that it may be a useful tool for other natural components of interest.

Supercritical extraction of natural products is a rapidly growing field; in 2008 Vatai et al⁵² published a study on extracting active compounds from elder berries and grape pomace using supercritical CO₂ with and without entrainers. Extracts were obtained at pressures as high as 30 MPa and temperatures up to 60°C. The extract contained high levels of anthocyanins, phenolic compounds, and flavonoids. The study concluded that the supercritical fluid extractions although successful, resulted in low yields; however moderate increases in temperature caused an increase in the amount of extract.

In 2004, M. Hamburger et al¹⁹ published a study involving supercritical extraction of chemicals from marigold, hawthorn and chamomile herbs. The study focused on comparing the different composition of extractables obtained at very high pressures using supercritical CO₂ with and without an ethanol co-solvent and determining the effect of using different compositions of the co-solvent. The experiments were done at pressure of 300 to 689 bar and

using 0 to 20% proportions of ethanol and a steady temperature of 50°C. The authors analyzed the samples using GC-MS and HPLC-PAD-MS. The authors reported extracting lipophilic, polyphenolic and glycosidic compounds.¹⁹

Zaidul et al⁶⁰ published a study on extraction and fractionation of palm kernel oil from palm kernel using supercritical CO₂ in 2006. The operating conditions used were at very high pressures that ranged from 20.7 MPa to 48.3 MPa at temperatures that were between 40 and 80°C. The samples obtained at high pressure were compared to those obtained using a traditional soxhlet extraction technique. The purpose of the study was to find alternatives to using cocoa butter in the food industry. The samples were finally analyzed using gas chromatography (GC) and pulsed nuclear magnetic resonance (PNMR) to determine the solid fat content of the extractables.⁶⁰

R. A. Jacques et al²⁰ published a study of extractables obtained from mate tea leaves (*Ilex paraguariensis*) using high pressure CO₂ in 2007. The experiments were done under operating conditions that had varying pressures from 100 to 250 bar and temperatures of 20 to 40°C. The extracts were analyzed with the assistance of gas chromatography coupled with mass spectrometry (GC/MS). The authors were able to identify 51 different compounds based on the peaks obtained from the chromatograms. The compounds identified included several esters, fatty acids and vitamins.²⁰

In 1999, Méndez-Santiago and Teja²⁹ published an important study that uses mathematical correlations to predict solid particle solubility in supercritical fluids. The authors work was motivated by the lack of experimental data available for different solid solubilities in supercritical fluids. Although equations of state can model such behavior to some extent, knowledge of many properties such as accentric factor and critical properties is usually required

and is seldom available for solid solutes. Hence having a mathematical model that can predict certain conditions where solubility is possible without using too many properties would be important and time saving. The authors' proposed model uses the Clausius-Clapeyron equation to obtain the sublimation pressure and incorporates the theory of dilute solutions into a semi-empirical relation to ultimately predict solubility.²⁹

In a recent review published by Abbas et al¹, different uses for supercritical fluids, specifically supercritical CO₂ as it pertains to the food industry was discussed. The review discusses the major advantages of using carbon dioxide in the supercritical phase. The authors continue to discuss the four different types of extraction mechanisms than can occur when using supercritical fluid extraction. The first type of extraction mechanism discussed was simple dissolution where the solute remains un-dissolved in the solid matrix with limited interactions. The second type involves interactions between the solvent and solute and is called desorption or adsorption depending on the interaction type; an example of this type of interaction occurs in carbon regeneration processes as mentioned in the review. The third mechanism is typically viewed in pigment extraction processes and is termed swelling where the solvent interacts with the solid phase. The final mechanism discussed in the review is reactive extraction where extractables are obtained from an insoluble solute interaction with the solvent hence leading only to the soluble components.¹

The mentioned four mechanisms are applied to processes such as extracting fats and lipids from different foods. This leads to the production of safe, fat-free foods that are commonly sold. The technology is also used, as Abbas et al¹ mentions for fortification of different vitamins from natural sources such as vitamin E from different natural oils. To enhance vitamin E, the technique discussed involves esterifying natural triglycerides using alcohols such as methanol to methyl esters, those methyl esters are then extracted using supercritical CO₂.

Supercritical fluids are commonly used to detect food contaminants and pesticides from tomatoes, potatoes, lettuce and apples as the review described. Supercritical CO₂ is a favorable method of choice because it easily isolates pesticides that have a low polarity and it leaves the system completely in the gas phase. In addition to extracting some pesticides, supercritical fluids are also used to analyze different foods to determine the presence or lack thereof of pesticides. This helps to ensure high safety standards for consumer goods. The same concept can be applied to determine contamination in soil and water as mentioned in the review.¹

Chapter 4

Fundamentals of Mass Transfer and Phase Equilibria Relating to Supercritical Fluid Extraction

Mass transfer principles as they relate to extraction of natural plants will be presented in this chapter. A discussion of both solid-fluid and solid-gas phase equilibria that can occur when dealing with supercritical fluids will also be included along with the different flow types and how they can affect mass transfer .

4.1 Mass transfer

Mass transfer is one of three main transport processes that govern most separation processes along with heat and momentum transfer. It occurs in different processes such as distillation, absorption, liquid-liquid extraction and crystallization. Mass transfer is characterized by having at least one non-stagnant component in the system despite of phase ¹⁷. However regardless of the phase involved in transport, basic principles are applicable. The basic governing equation that applies to transfer including mass is written as:

$$\text{Rate of a transfer process} = \frac{\text{driving force}}{\text{resistance}} \quad (1)$$

Mass transfer is greatly influenced by state parameters; in the case of gas extraction, one of the most influential factors is pressure ⁶. Different types of flow which can occur depending on experimental conditions; flow such as laminar is associated with a low Reynolds number and turbulent flow which occurs at higher solvent flow rates typically has a large Reynolds number also have an effect on mass transfer. These concepts will be described in greater detail later on in this chapter.

4.2 Solid Extraction Using Supercritical Fluids

The starting material in this thesis is a solid and the extraction is done using supercritical CO₂–ethanol mixture. Typically, the operation involves a continuous stream of the solvent mixture going through the starting materials. The solid substrate generally forms a fixed bed in which the supercritical solvent mixture is allowed to flow and continuously extracts the soluble components⁶. If the solvent is allowed to contact the starting solid for an adequate amount of time, the soluble materials are usually fully extracted from the starting solid in the same direction as the solvent flow. Thus, the concentration of soluble materials decreases from the region where the starting solid is contained and increases at the same rate in the region in which the solvent flows.⁶

The selectivity of soluble components extracted using supercritical fluids is highly dependent on many factors such as operating conditions like temperature and pressure as previously described. On the other hand, other forces can affect if not the solubility of the components, the rate of extraction, such as gravitational and centrifugal forces. The lower the solvent flow, the higher the influence of gravity becomes and thus the greater the effect on the extraction process.⁶

When working with natural products and plant materials, such as the case for this project with blueberry and cranberry powders, factors other than gravitational forces and operating conditions may play a key role in the extraction process. For plants, the mechanism of transport might differ in the same substance from sample to sample depending on the harvesting conditions, treatment methods used, harvesting period and so on⁶. In addition the particle sizes may be different causing different mechanisms for the extraction such as adsorption on the outer surface or onto the surface of the pores or even through the material of

the plant; all of which affect the extraction process. The structure of a typical plant cell is shown below:

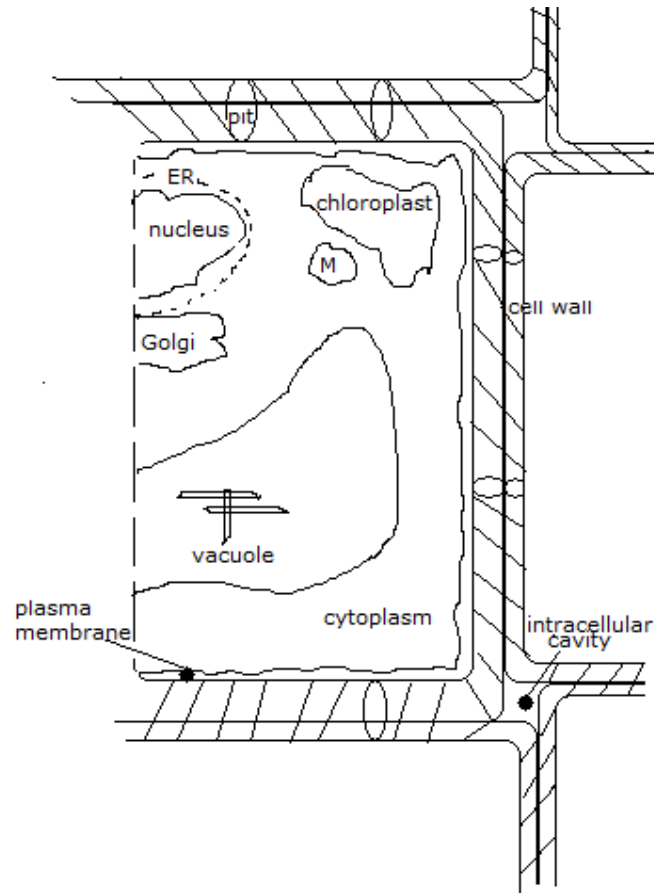

Figure 3: Structure of a Plant Cell ⁶

The plant cell shown in Figure 3 is part of the solid material that is inside the extraction vessel. The intermediate structures within the tiny cells are what can affect the extraction process by having a big affect on the mass transfer within and through the cell. Essentially the extracted materials are dissolved in the cytoplasm of the cell but intermediate structures such as the semi-permeable cell wall, the plasma-membrane and the intercellular cavities play an important role in the extraction process by facilitating the diffusion step ⁶. In general the

process of getting extracts from a solid starting material occurs in the sequence described in the next portion of this chapter ⁶.

When starting with a solid such as plant cells, the supercritical solvent (mix) is absorbed into the matrix of the plant causing the walls of the plant cell to swell facilitating mass transport by decreasing resistance. The soluble compounds within the cells begin dissolving as the solvating power of the solvent is maximized by the decreased resistance from the initial step. The newly dissolved components start to diffuse out of the solid surface of the plant cell. Once through the outer surface, a phase change might take place. Finally the extracted materials are removed from the surface of the cell into the solvent stream.

Since the process of getting extracts from solid starting materials have been explained, perhaps it is also important to explain the steps the solvent undertakes with respect to time to extract the soluble materials. The basic form of the extraction occurs in a manner similar to the following graph:

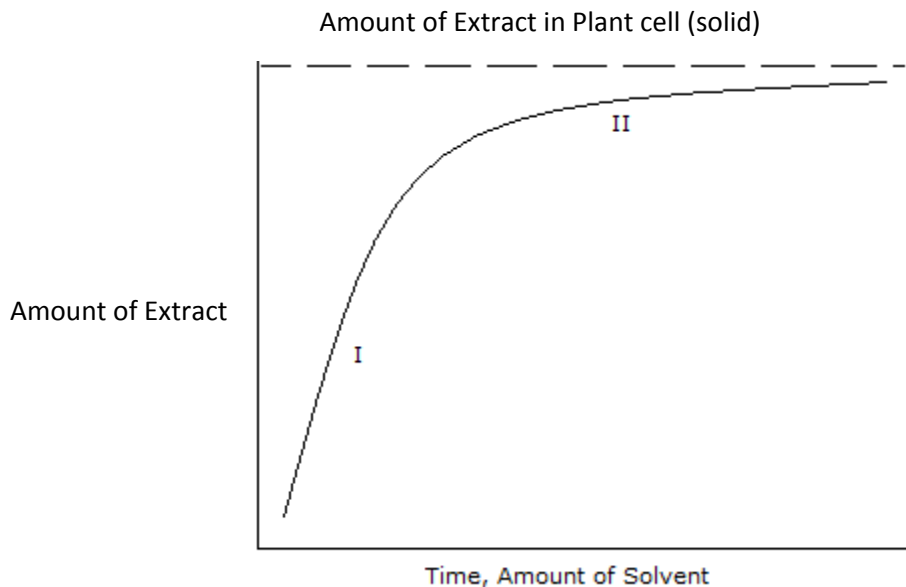

Figure 4: Total Amount of Extract With Respect to Extraction Time ⁶

The graph shows the response curve for the total amount of extract with respect to the time of extraction as the amount of solvent increases⁶. The initial linear portion of the graph describes a constant extraction rate while as time progresses, a limit is approached and the amount of extract ceases to increase as shown by the second portion of the curve⁶. On the other hand, the initial amount of extract in the starting solid decreases with respect to time and amount of solvent that passes through it.

From the solid starting material's position, the level of soluble components in the solid decrease as the solvent is passed through the solid and as the duration of the extraction increases. With respect to the solvent, the extracted materials increase with time as more solvent is passed through the solid starting material. This allows for an axial concentration profile both in the gas and solid phases with respect to the solvent due to the kinetics of mass transfer⁶. A graphic description of this concept using a series of concentration profiles with respect to time is illustrated in Figure 5.

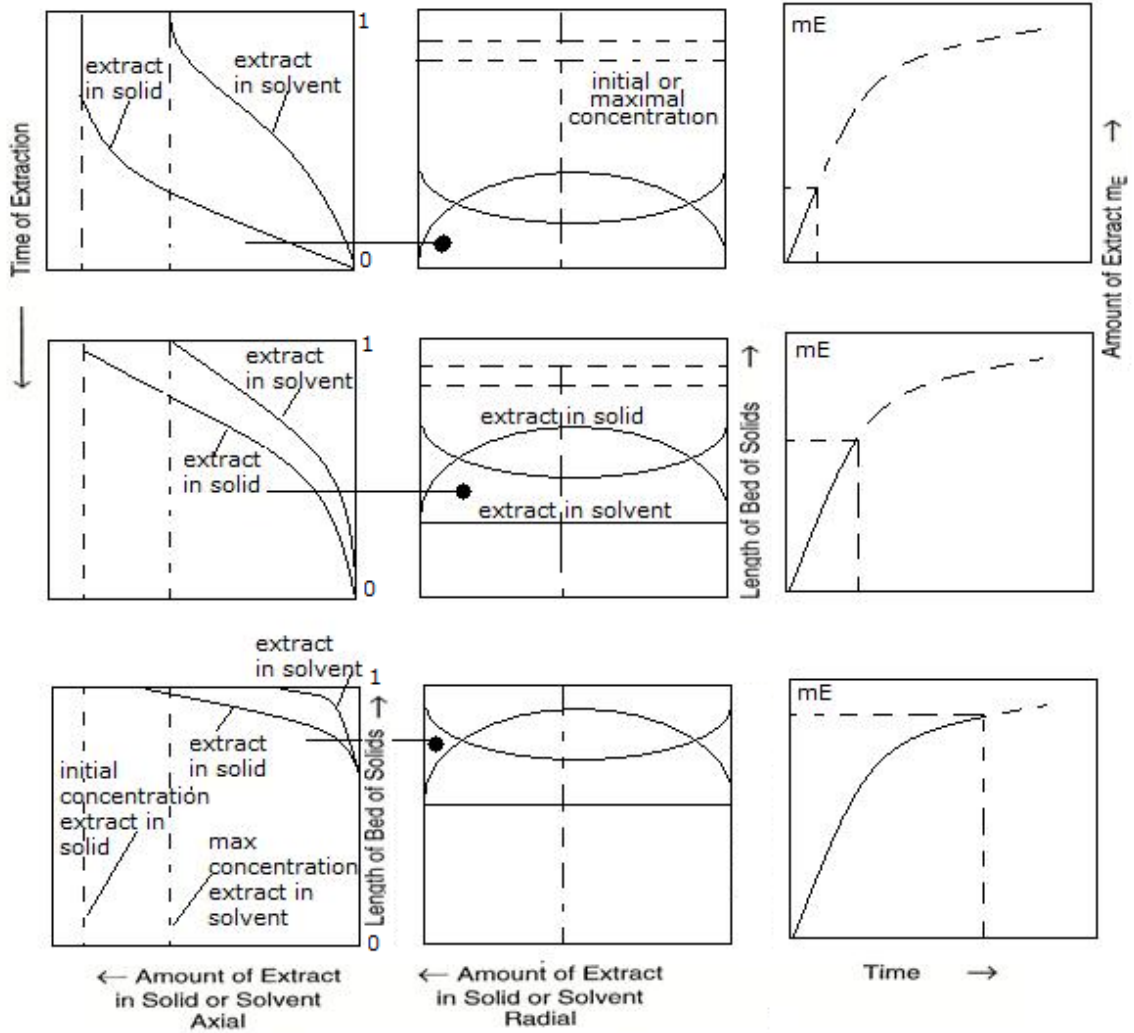

Figure 5: Concentration Profiles Illustrating Path of Extraction from a Solid Material ⁶

4.3 Solid-Fluid Equilibria

Phase equilibria of mixtures are of particular importance in order to be able to define system properties and be able to work with them. There are several types of phase equilibria that include liquid-liquid, liquid-vapor, liquid-liquid-vapor, liquid-solid- vapor, solid-liquid, solid-liquid-liquid and solid-vapor; the next section will discuss some of the equilibria types relevant to this work.

Understanding the phase equilibria of systems involving solid-fluid mixtures is as crucial as understanding basic concepts of mass transfer. Processes involving two or more phases such as extraction processes as in the case of this work which uses blueberry and cranberry powder, both solid starting materials, and a supercritical CO₂-ethanol mixture as a solvent; are said to have solid-fluid equilibrium²⁷. The solubility of the solids in the gas phase of the supercritical fluid can be obtained using the following correlation assuming the solid is a pure component²⁷:

$$y_2 = E \frac{P_2^s}{P} \quad (2)$$

Where

E is the enhancement factor

P_2^s is the sublimation pressure of the solute

Using operating temperature and the fugacity coefficient, an expression to solve for the enhancement factor is obtained as follows:

$$E = \frac{\exp[(P - P_2^s)v_2^{sol}]}{\varphi_2} \quad (3)$$

Where

φ_2 is the fugacity coefficient of the solid solute

v_2^{sol} is the solid molar volume

Temperature effects on solid-fluid systems vary depending on different factors in the system that can have an effect on the density and solid volatility. For ideal systems, equations predict that an increase in temperature increases the solubility of the system overall⁵⁶. This is not always the case when there is a supercritical solvent involved in the system.

On the other hand, pressure has a direct effect on the density of the fluid above the critical temperature²⁷. It is also noted that solubility increases in the supercritical region

drastically by several orders of magnitude as the density is increased due to pressure effects. This phenomenon is attributed to a drastic decrease in the solute's fugacity coefficient.

At the supercritical region, the distinction between the liquid and gas states begins to disappear as supercritical fluids display characteristics of both⁵⁸. Supercritical fluids possess low viscosities, usually between 1 to 9 *10⁻⁴ g/cm-s and low interfacial tension similar to those of gases. Therefore determining solubility of solids in supercritical fluids can be challenging due to the fact that supercritical fluids can be modeled as either expanded liquids or compressed gases². Modeling supercritical fluids as compressed gases is very similar to the liquid model. For the compressed gas model, at constant molar volume and a small vapor pressure, the fraction of solid dissolved is given by:

$$y_2 = \frac{P_2^S \exp\left(\frac{v_2^S P}{RT}\right)}{\varphi_2 P} \quad (4)$$

Where

P_2^S is the solid's vapor pressure

v_2^S is the solid's molar volume

φ_2 is the solid's fugacity coefficient in the supercritical fluid phase

4.4 Solid-Liquid-Vapor Equilibrium

Ternary systems tend to be more complex to model; however in many cases it is very important to understand the phase behavior and equilibrium of ternary systems that have different phases especially when a supercritical solvent is involved. The equilibrium of a solid-liquid-vapor system can be modeled from binary equilibrium data for solid-liquid equilibrium

and liquid-vapor equilibrium according to a study done in 2005 by Mukhopadhyay et al³². In order to obtain solid-liquid-vapor equilibrium, initially two operating variables must be fixed in order to decrease the degrees of freedom in the system. In such a case, only three mole fractions remain as unknowns out of a possible five where the other two are assumed to have a sum equal to one in each phase. This can be represented by the following set of equations:

$$\bar{f}_1^V(T, P, y_1) = \bar{f}_1^L(T, P, x_1) \quad (5)$$

$$\bar{f}_2^V(T, P, y_2) = \bar{f}_2^L(T, P, x_2) \quad (6)$$

$$f_3^S(T, P) = \bar{f}_3^L(T, P, x_3) = \bar{f}_3^V(T, P, y_3) \quad (7)$$

Where superscripts

1 is supercritical solvent

2 is liquid solvent

3 is solid solute

\bar{f} is the partial fugacity of a given component in solution

Hence the liquid fugacity can be represented by:

$$\bar{f}_3^L = \gamma_3 x_3 f_3^{\circ L} \quad (8)$$

Where

$f_3^{\circ L}$ is the standard state fugacity in liquid phase

γ is the activity coefficient

The solid phase fugacity can be obtained using a relationship found by Dixon and Johnston obtained from the same work by Mukhopadhyay et al³²:

$$f_3^s(T, P) = P_3^s \varphi_3^s \exp \left[\frac{v_3^s(P, P_3^s)}{RT} \right] \quad (9)$$

Where

P_3^s is the sublimation pressure

v_3^s is the molar volume of the solid

The fugacity in the solid phase may also be obtained through equations of state; Kikic et al. obtained from a publication by Mukhopadhyay et al³² gave the following equation:

$$\ln f_3^s(T, P) = \ln f_3^L(T, P) + \frac{(v_3^s - v_3^L)(P - P_{tp})}{RT} - \frac{\Delta H_3^f}{RT_{tp}} \left(\frac{T_{tp}}{T} - 1 \right) \quad (10)$$

Where

T_{tp} is the triple point temperature

ΔH_3^f is the heat of fusion at the triple point and P_{tp} is the triple point pressure

If the solute in the system were to exist in the vapor phase, then the mole fraction would have to be obtained using solid-vapor equilibrium expressions given as:

$$f_3^s(T, P) = \bar{f}_3^V(T, P, y_3) \quad (11)$$

$$y_3 = \frac{P_3^s \varphi_3^s \exp \left[\frac{v_3^s P}{RT} \right]}{P \bar{\varphi}_3^V} \quad (12)$$

4.5 Flow

Two different types of fluid flow can occur in a system, either laminar or turbulent flow and can be predicted by mathematical means such as calculating the Reynolds number, discussed later in this chapter. The type of flow is determined by system conditions such as velocity¹⁷. Laminar flow occurs when fluid velocities are relatively slow causing a steady smooth pattern of flow. This type of flow can be described in a system being steady and having different layers simultaneously flowing without disrupting one another and is characterized by having a low Reynolds number.

The Reynolds number of a system describes the transition state between laminar and turbulent flow with respect to the diameter of the tube in which the fluid is flowing as well as the viscosity, density and velocity of the fluid¹⁷. This dimensionless number is given by:

$$N_{Re} = \frac{Dv\rho}{\mu} \quad (13)$$

Where:

N_{Re} is the Reynolds number

D is the diameter of the pipe

v is the average velocity of the fluid

ρ is the fluid density

μ is the fluid viscosity

For laminar flow inside a cylindrical pipe, the Reynolds number typically has values less than 2100. For values greater than 2100 but less than 4000, flow can either be viscous or laminar where the exact type of flow is not as easily predicted as simple laminar or turbulent; at

these values, flow is known to be in a transition region. Turbulent flow has a relatively high Reynolds number as previously mentioned above 4000¹⁷.

Turbulent flow is the second type of fluid flow that can occur. It is the opposite of laminar flow, as it occurs at higher velocities. In turbulent flow, almost chaotic fluid molecule movements are present where there is movement in all directions. Eddies are typically developed in this type of flow. Turbulent flow is characterized by having a high Reynolds number of over 4000 in a cylindrical pipe. This is obtained by the ratio of kinetic forces to viscous forces in a given fluid system¹⁷.

Many forces contribute to the determination of the type of flow in a system. Abnormalities or chaos in a velocity can be attributed to having layers of fluid contacting each other at different velocities or due to contacting a solid form such as a particle or a plant cell as in the case of this work. In turbulent flow, velocity tends to flow in random different directions causing turbulence in the system¹⁷. This turbulence causes eddies to form as previously mentioned; interestingly though, although eddies are formed as a result of turbulence, flow within eddies is laminar due to the magnitude of their size¹⁷.

The intensity of the turbulence can be an important factor that affects heat and mass transfer coefficients, as well as the separation and boundary layer transitions. In addition simulations rely on the intensity to equal the Reynolds number in order to closely approximate models with turbulent flows.

Calculating Re for CO₂ at a pressure of 2100 psia, a temperature of 40°C given a diameter $D= 7.36 \cdot 10^{-4}$ m, CO₂ density $\rho= 780.4$ kg/m³, average fluid velocity $v= 0.47$ m/s and fluid viscosity $\mu= 67.74 \cdot 10^{-6}$ kg.s/m.s².

$$N_{Re} = \frac{7.3 \times 10^{-4} \text{ m} \cdot 0.47 \frac{\text{m}}{\text{s}} \cdot 780.4 \frac{\text{kg}}{\text{m}^3}}{67.74 \times 10^{-6} \frac{\text{kg} \cdot \text{s}}{\text{m} \cdot \text{s}^2}} = 3988 \quad (14)$$

Given a Reynolds number of 100, 2100, 3988, 30,000 the flow velocities are calculated using the previous equation and outlined in Table 3.

Table 3: Velocity at Different Reynolds Values

Re	Velocity (m/s)
100	0.012
2100	0.250
3988	0.470
30,000	3.54

4.6 Mass Transfer Coefficients

Mass transfer coefficients can be an important tool in determining mass transfer gradients in a given system. They can also be used to closely approximate extraction from solid starting materials since fluid residence times are relatively high due to the nature of the slow extraction processes. However, this method of approximation can be limited by the physical properties of system components and difficulty of the reaction; nonetheless it is a useful tool. The amount of extracted material per unit time can be approximated using the following equation:^{2,6}

$$\frac{dm}{dt} = \hat{m} = -m_s \frac{dc_m}{dt} \quad (15)$$

Where

\hat{m} is amount of component extracted

m_s is the mass of solid substrate

c_m is mean concentration of extracted components in solid starting material

The previous equation can be written in terms of mass transfer coefficients by relating the mass transfer coefficients in the solid and fluid phase to the transportation of extracted substances to the bulk of fluid as given in the following expressions ⁶:

$$\hat{m} = \beta_S A (c_m - c_0) \quad (16)$$

$$\hat{m} = \beta_F A (c_0 - c_\infty) \quad (17)$$

Where

β_S is the mass transfer coefficient in the solid phase

β_F is the mass transfer coefficient in the fluid phase

c_0 is initial mean concentration of extracted components in solid starting material

c_∞ is concentration of extracted components in bulk of fluid

A is the mass transfer area in the system

The total resistance, k , due to the forces of mass transfer is given by the addition of the inverse of both mass transfer coefficients in the solid and fluid phases as shown below ⁶:

$$\frac{1}{k} = \frac{1}{\beta_S} + \frac{1}{\beta_F} \quad (18)$$

For the previous equation, in the case where resistive forces due to mass transfer are greater in the solid phase, it can be assumed that $k \approx \beta_S$. For systems where a phase transition may occur, a second equation is used in addition to the previous equation that accounts for the interface equilibrium. The equation models the extraction process post initial extraction time by taking the total mass transfer coefficient as a constant where the following resulting equation is obtained for the mean concentration ⁶:

$$\frac{c_m - c_\infty}{c_0 - c_\infty} \approx \exp\left(-\frac{kA}{m_S c_0} t\right) \quad (19)$$

More information on mass transfer coefficients is available in many literary sources such as the Gas Extraction book by G. Brunner ⁶.

In order to obtain the mass transfer coefficient at a Reynolds number of 3988, the Prandtl, the Nusselt, the Schmidt and the Sherwood numbers must be calculated at first, detailed sample calculations are provided in Appendix B.

The Prandtl number is a dimensionless number that relates kinematic viscosity to thermal diffusivity and can be calculated as shown given the viscosity, thermal conductivity and specific heat of CO₂:

$$Pr = \frac{\nu}{\alpha} = \frac{c_p \mu}{k} \quad (20)$$

The Nusselt number is the ratio of convective to conductive heat transfer and can also be related to the Reynolds and the Prandtl numbers as shown below:

$$Nu = 2 + 0.6 * Re^{\frac{1}{2}} * Pr^{\frac{1}{3}} \quad (21)$$

The Schmidt number is another dimensionless number that relates viscosity to mass diffusivity and is given for CO₂ as ⁴²:

$$Sc = \frac{\nu}{D} = \frac{\mu}{\rho * D} \quad (22)$$

The Sherwood number is a correlation for mass transfer under conditions of forced convection and can be calculated as shown for a Reynolds number of 3988:

$$Sh = \frac{K_c * Diameter}{D} = 2 + 0.6 * Re^{\frac{1}{2}} * Sc^{\frac{1}{3}} \quad (23)$$

Rearranging the Schmidt correlation and solving for D at the same conditions yields:

$$D = \left(\frac{Sc \cdot \rho}{\mu} \right)^{-1} \quad (24)$$

Now plugging back into the Sherwood equation and solving for the mass transfer coefficient K_c :

$$K_c = \frac{Sh \cdot D}{\text{Diameter}} \quad (25)$$

At different values of Reynolds and at higher velocities, the mass transfer coefficient changes as shown in Table 4:

Table 4: Phase Effect on Velocity and Mass Transfer Coefficient

Reynolds Number	Velocity SC phase (m/s) (150 bar and 40°C)	Velocity Vapor Phase (m/s) (1 bar and 25°C)	Velocity Liquid Phase (m/s) (71 bar and 25°C)	Mass Transfer Coefficient (m/s)
100	0.012	$1.14e^{-4}$	$5.28e^{-7}$	$1.68e^{-6}$
2100	0.250	$2.39e^{-3}$	$1.11e^{-5}$	$7.05e^{-6}$
4000	0.470	$4.54e^{-3}$	$2.11e^{-5}$	$9.67e^{-6}$
30,000	3.54	$3.42e^{-2}$	$1.58e^{-4}$	$2.62e^{-5}$

As shown in Table 4, with increasing Reynolds number, the volumetric flow rates increase as the turbulent region is approached and the mass transfer coefficient also increases. As the Reynolds number reaches the turbulent flow region, layers of fluid begin contacting each other at different velocities and contact the solid at different points. The increase in velocity causes soluble components to get picked up into the bulk of the fluid more rapidly and thus decreases the extraction time.

4.7 Gibbs Free Energy

The Gibbs free energy equation utilizes the first and second laws of thermodynamics to complete the requirements for thermodynamic equilibrium. It is defined as the maximum work

obtained from a closed, reversible system as it changes from the initial to the final state. That work energy (ΔG) is equal to the work exchanged by the system and the surroundings minus any work done by pressure forces. In mathematical terms, the basic form is shown below ⁵⁶:

$$G = H - TS \quad (26)$$

Where

G is Gibbs work energy

H is enthalpy of system

T is temperature

S is entropy

The previous equation can be rewritten for a single phase system in the differential form:

$$d(nG) = (nV)dP - (nS)dT + \sum_i \mu_i dn_i \quad (27)$$

Where

dn_i is the discrepancy in number of moles in the system

At constant pressure and temperature, equation (27) is simplified and becomes a representation of the rate of change in the Gibbs energy with respect to the reaction in the system and is given by ⁴⁶:

$$\sum_i \mu_i dn_i = 0 \quad (28)$$

Where Gibbs defines μ_i at constant volume and entropy as the amount of change in energy of a system with the introduction of additional particles.

For an ideal gas at a sufficiently low pressure such as 1 bar or vacuum, the Gibbs equation becomes:

$$\int_{\mu^{\circ}}^{\mu} d\mu = \int_{P^{\circ}}^P \bar{V} dP \quad (29)$$

Where $\bar{V} = \frac{RT}{P}$ as obtained from the ideal gas law. And the superscript $^{\circ}$ refers to the standard state.

Rearranging and plugging $\bar{V} = \frac{RT}{P}$ into (29), the equation becomes:

$$\mu - \mu^{\circ} = \int_{P^{\circ}}^P \frac{RT}{P} dP = RT \ln \frac{P}{P^{\circ}} \quad (30)$$

Where

$$\mu = \mu^{\circ} + RT \ln \frac{P}{P^{\circ}} \quad (31)$$

Although it is a useful characteristic for phase equilibria, the existence of μ depends on the values of the internal energy and entropy of a given system. Thus at the absolute values, μ_i approaches negative infinity. In addition, since there is no equation for the molar volumes, \bar{V} , of real gases, equation (31) can only be used for ideal gases. Using the concept of fugacity, f , which is defined in units of pressure⁴⁶, can be a better alternative to the limitations exhibited by μ_i and may be used to approximate the chemical potential of real gases.

Fugacity is defined in terms of μ as follow:

$$\mu = \mu^{\circ} + RT \ln \frac{f}{f^{\circ}} \quad (32)$$

For ideal gases, $f=P$ and as P approaches zero, the limit of the fugacity function becomes:

$$\lim_{P \rightarrow 0} \frac{f}{P} = 1 \quad (33)$$

Whereas the dimensionless ratio

$$\frac{f}{P} \quad (34)$$

is defined as the fugacity coefficient, φ , and equation (34) becomes:

$$\varphi = \frac{f}{P} \quad (35)$$

The fugacity coefficient is applicable to any species regardless of phase (vapor, liquid or gas). For ideal gases, φ is equal to 1. Whereas for pure components, the fugacity coefficient is defined as⁴⁶:

$$\ln \varphi = \int_0^P (Z - 1) \frac{dP}{P} \quad (36)$$

Where Z is the compressibility factor

The fugacity coefficient is defined for the vapor liquid equilibrium of a pure component, i , as follows:

$$\varphi_i = \frac{f_i^{sat}}{P_i^{sat}} \quad (37)$$

Where the fugacity coefficient for component i in the vapor phase is equal to that in the liquid and in the saturated phases⁴⁶.

$$\varphi_i^v = \varphi_i^l = \varphi_i^{sat} \quad (38)$$

It is usually easier for explanatory purposes to assume ideal behavior of components in a given system; however that is not the case in most instances; in fact it is expected to have non-

idealities especially in mixtures. For this reason, excess properties exist for Gibbs energy, enthalpy, volume and entropy to help reveal system non-idealities. Excess function values approach zero as purity of components inside a system increases. The excess function for Gibbs is defined in the basic form as ⁴⁶:

$$G^E \equiv G^{ac} - G^{id} \quad (39)$$

Where

G^E is the excess Gibbs function

G^{ac} is the actual Gibbs for the solution

G^{id} is the Gibbs for the ideal solution

Using the activity coefficients and rearranging in terms of excess volume and enthalpy, the excess Gibbs property can be rewritten as:

$$d\left(\frac{nG^E}{RT}\right) = \frac{nv^E}{RT}dP - \frac{nH^E}{RT^2}dT + \sum_i \ln\gamma_i dn_i \quad (40)$$

From equation (38), excess volume and excess enthalpy can be defined in terms of G^E :

$$\frac{v^E}{RT} = \left[\frac{\partial(G^E/RT)}{\partial P} \right]_{T,x} \quad (41)$$

$$\frac{H^E}{RT} = -T \left[\frac{\partial(G^E/RT)}{\partial T} \right]_{P,x} \quad (42)$$

Excess entropy is defined as:

$$S^E = -\partial(G^E/\partial T)_{P,x} \quad (43)$$

Non idealities in systems can be better approximated using excess functions as mentioned previously; however causes for system deviations from ideality may also be a result of temperature changes. The initial temperature at which a system begins to deviate or become non-ideal is known as the consolute temperature denoted as T^c and given by the following equation ³⁸:

$$T^c = \frac{A}{2R} \quad (44)$$

Where

A is a temperature parameter

The consolute temperature can be an upper or a lower temperature. More systems exhibit an upper consolute temperature than those who exhibit lower consolute temperature. The upper consolute temperature is defined as the highest temperature in which two phases can exist which can be achieved if $\frac{A}{RT}$ decreases with increasing temperature. The opposite is also true, where if $\frac{A}{RT}$ increases with increasing temperature, a lower consolute temperature is obtained; this is common in mixtures that form hydrogen bonding ³⁸.

4.8 Equations of State

Equations of state relate volume, pressure and temperature of a substance where two of the properties are independent ⁵⁶. So many equations of state exist, but no single equation of state can approximate more important properties such as entropy, enthalpy, density of vapor or liquid phases, vapor pressure or critical properties of mixtures. Cubic equations of state are used to approximate phase equilibria of different systems. Many equations exist, however different equations also have different mathematical models for obtaining activity coefficients. Activity

coefficients are a useful tool for non-ideal systems that have more than one component and can be used to approximate phase behavior. The basic form of cubic equations of states is ⁵⁸:

$$P = \frac{RT}{v-b} - \frac{a(T)}{v^2+v(b+c)-(bc+d^2)} \quad (45)$$

Although many equations of state rely on the basic structure of equation (45), each equation has important variations and sub-equations for obtaining the constants that make it unique. However it is also important to mention that different equations of state have different restrictions; no one equation can be deemed superior for all systems. Every proposed and accepted equation has certain limitations, some equations are valid in a particular temperature or pressure range while others are only valid for certain classes of chemicals; however overall they are decent approximates of phase equilibria ⁵⁶.

4.9 Van Der Waals

One of the earliest proposed equations of state is the van der Waals equation; it is given in the basic form as ⁵⁶:

$$RT = (P + \frac{a}{v^2})(v - b) \quad (46)$$

Where a is termed the attraction parameter and b is the repulsion parameter and are defined by the following equations ⁵⁶:

$$a = \frac{27R^2T_c^2}{P_c} \quad (47)$$

$$b = \frac{RT_c}{8P_c} \quad (48)$$

The van der Waals parameters are given for mixtures in terms of those of a pure component using mixing rules proposed by Lorentz and Berthelot, as follows ⁵⁶:

$$a = (\sum y_i \sqrt{a_i})^2 = \sum \sum y_i y_j \sqrt{a_i a_j} \quad (49)$$

$$b = \sum y_i b_i \quad (50)$$

Where the compressibility factor, z , is given by:

$$z = \frac{PV}{RT} \quad (51)$$

Although it is considered one of the pioneer equations of state, the van der Waals equation has severe limitations, mainly in the fact that in most systems it is very inaccurate and the equation is now considered a simple model that offers a few corrections to the ideal gas law ⁵⁶. The limitations for the van der Waals equation are most obvious in the prediction of the critical z value, denoted Z_c , as a value of 0.375; whereas it has been proven that most real fluids have a Z_c value in the range of 0.27 ³⁰. Far more superior equations have been introduced since then.

4.10 Peng-Robinson

The Peng-Robinson (PR) equation of state was developed in 1976 to partially cure some of the problems with earlier equations. The equation focuses on several important factors that include having parameters modeled in terms of critical temperature and pressure as well as the accentric factor. The equation aims at better approximating liquid densities and compressibility factors, Z_c . Finally, the original mixing rules employed with PR contain only one binary interaction parameter that is independent of temperature and pressure ⁵⁶. The basic form of the equation is given by:

$$P = \frac{RT}{V-b} - \frac{a(T)}{v^2 + 2bV - b^2} \quad (52)$$

Where a and b are given at the critical temperatures and pressures by:

$$a(T_c) = \frac{0.45724R^2T_c^2}{P_c} \quad (53)$$

$$b(T_c) = \frac{0.07780RT_c}{P_c} \quad (54)$$

However, at temperatures other than the critical temperature, a(T) is corrected by a vapor pressure correlation and denoted as α , given by the following two equations:

$$a(T) = a(T_c)\alpha(T_r, \omega) \quad (55)$$

$$\alpha^{0.5} = 1 + (1 - T_r^{0.5})(0.37464 + 1.5422\omega - 0.26992\omega^2) \quad (56)$$

Where Z_c is given a value of 0.307 which is much closer to the true value of many substances; that is part of the reason why the PR equation of state is a better approximate of liquid densities

⁵⁶. For mixtures, the PR parameters are obtained using the following set of equations:

$$a\alpha = \sum \sum y_i y_j (a\alpha)_{ij} \quad (57)$$

$$b = \sum y_i b_i \quad (58)$$

$$(a\alpha)_{ij} = (1 - k_{ij})\sqrt{(a\alpha)_i(a\alpha)_j} \quad (59)$$

4.11 NRTL

Nonrandom two-liquid equation (NRTL) is a liquid activity model that utilizes the excess Gibbs (G^E) energy to obtain the corresponding parameters. The model assumes the system to contain a binary mixture of cells of types 1 and 2 that are surrounded by a variety of the same molecules. The Gibbs reaction for the two cell types are given by:

$$g^{(1)} = x_{11}g_{11} + x_{21}g_{21} \quad (60)$$

$$g^{(2)} = x_{12}g_{12} + x_{22}g_{22} \quad (61)$$

Where

g_{11} and g_{22} are the pure substances' Gibbs energies ⁵⁶

NRTL utilizes the following equations to obtain the mole fractions of both species in a given system:

$$\frac{x_{21}}{x_{11}} = \frac{x_2 \exp\left(-\frac{\alpha_{12}g_{21}}{RT}\right)}{x_1 \exp\left(-\frac{\alpha_{12}g_{11}}{RT}\right)} \quad (62)$$

$$\frac{x_{12}}{x_{22}} = \frac{x_1 \exp\left(-\frac{\alpha_{12}g_{12}}{RT}\right)}{x_2 \exp\left(-\frac{\alpha_{12}g_{22}}{RT}\right)} \quad (63)$$

Where α is a constant in the previous equations (62, 63) under the assumption that the total mole fraction of each species sums up to one as given by the following equations ⁵⁶:

$$x_{21} + x_{11} = 1 \quad (64)$$

$$x_{12} + x_{22} = 1 \quad (65)$$

Given the mole fractions of both species in the system the excess Gibbs energy can be obtained by ⁵⁶:

$$\frac{G^E}{RT} = x_1 x_2 \left[\frac{\tau_{21} G_{21}}{x_1 + x_2 G_{21}} + \frac{\tau_{12} G_{12}}{G_{12} x_1 + x_2} \right] \quad (66)$$

Where the independent parameters τ_{12} and τ_{21} are given by the following equations ⁵⁶:

$$\tau_{12} = \frac{g_{12} - g_{22}}{RT} \quad (67)$$

$$\tau_{21} = \frac{g_{12} - g_{11}}{RT} \quad (68)$$

The individual component Gibbs energies, G_{12} and G_{21} are given by the following equations⁵⁶:

$$G_{12} = \exp(-\alpha_{12}\tau_{12}) \quad (69)$$

$$G_{21} = \exp(-\alpha_{12}\tau_{21}) \quad (70)$$

Defining all the variables to the previous equations, the activity coefficients using the NRTL equation can be obtained by⁵⁶:

$$\ln\gamma_1 = x_2^2 \left[\tau_{21} \left(\frac{G_{21}}{x_1 + x_2 G_{21}} \right)^2 + \frac{\tau_{12} G_{12}}{(G_{21} x_1 + x_2)^2} \right] \quad (71)$$

$$\ln\gamma_2 = x_1^2 \left[\tau_{12} \left(\frac{G_{12}}{x_2 + x_1 G_{12}} \right)^2 + \frac{\tau_{21} G_{21}}{(G_{21} x_2 + x_1)^2} \right] \quad (72)$$

The NRTL equation is used quite frequently because of its capacity to very closely approximate mixture behavior using binary parameters better than other equations of state that use similar techniques. However, a discouraging feature of the NRTL equation is that it requires three parameters versus other activity coefficient models.⁵⁶

4.12 Mixing Rules

In order to be able to closely approximate properties of a given system with two or more components, equations of state must be coupled with the proper mixing rules. Mixing rules are essentially a relationship that describes the dependence of the constants in a given system on the composition.³⁸

One of the earliest mixing rules to be implemented was the van der Waals rules for constants a and b shown below:

$$a = \sum_{i=1}^m \sum_{j=1}^m y_i y_j a_{ij} \quad (73)$$

Where

a_{ij} is the attractive forces between molecule i and molecule j

m is the number of components in the mixture

$$b = \sum_{i=1}^m y_i b_i \quad (74)$$

The equation for constant a , equation (73), makes several assumptions that allow for its use. It assumes that the molecules in the mixture are fairly close in the size range up to moderate density values. The equation is also modeled to take the intermolecular attractive forces into account as shown by the variable a_{ij} . Finally, the equation assumes that individual fugacities in the mixture are sensitive to the value of a ³⁸. For simplicity purposes equation (74) makes only one assumption which is that the molecular volumes are taken as an average as opposed to finding b in terms of size proportionality of the molecules in the mixture.³⁸

It is useful to mention that for cases where $i \neq j$, a second equation is used that was proposed by Berthelot called the geometric-mean assumption. It is an empirical correlation that is commonly used for mixtures and for measuring intermolecular forces. The geometric-mean assumption is given as³⁸:

$$a_{ij} = (a_i a_j)^{1/2} \quad (75)$$

The van der Waals rules are an important tool; however their dependence on density and given all the underlying assumptions cause them to be invalid for a very large range.

Another useful set of mixing rules are the Wong-Sandler rules which are independent of density. They have been shown to produce good results both in the high as well as the low

density regions for a variety of mixtures³⁸. Wong-Sandler mixing rules are unique in that they enable close estimations of mixture properties at high pressures using low pressure vapor liquid information. The constants b and a are given by Wong-Sandler as:

$$b_{mixt} = \frac{\sum_i \sum_j x_i x_j \left(b - \frac{a}{RT} \right)_{ij}}{1 - \frac{a_{\infty}^E}{CRT} - \sum_i x_i \left(\frac{a_i}{b_i RT} \right)} \quad (76)$$

$$a_{mixt} = b_{mixt} \left[\sum_i x_i \frac{a_i}{b_i} + \frac{a_{\infty}^E(x_i)}{C} \right] \quad (77)$$

Where

a_{∞}^E is excess molar Helmholtz energy at infinite pressure

a_{mixt} is constant a in the mixture

b_{mixt} is constant b in the mixture

C is equation of state dependent constant

For Peng-Robinson, C is given a value of -0.62322 and for van der Waals, it is given a value of -1

³⁸.

Chapter 5

Experimental Setups, Equipment Specifications and Experimental Procedures

In this chapter, both experimental setups used to conduct the experiments are discussed. The specifications for all used equipment are also highlighted. Finally, the detailed experimental procedure will be discussed along with shutdown procedures and equipment cleaning.

5.1 High Pressure Experimental Setup

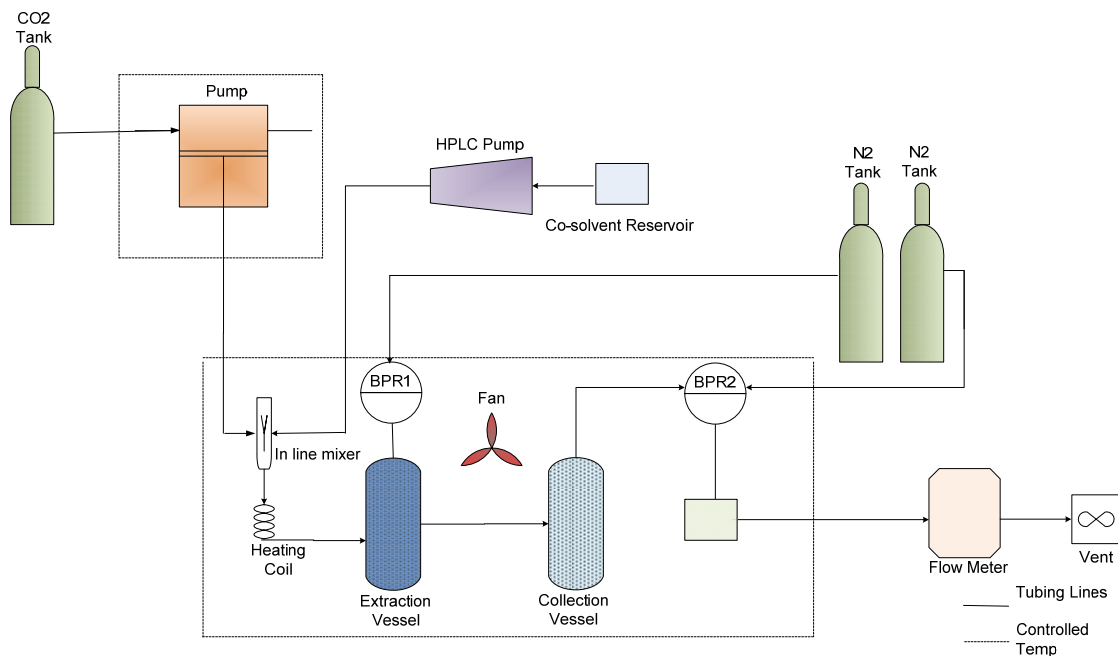

Figure 6: High Pressure Experimental Setup

Experimental Setup Using Supercritical CO₂ and Ethanol for the Extraction process is shown in Figure 6. The setup shows the two pumps used to introduce the solvent and the co-

solvent to the system. The first pump introduces the CO₂ after the temperature is decreased. The second pump introduces the ethanol and both mix in an in-line mixer as shown in Figure 6 before entering the first vessel. The figure also shows how both the fractionation and extraction vessels are connected to air activated back pressure regulators (BPRs). The extraction and fractionation section of the setup is in a constant temperature air bath. The equipment specifications used in the setup are discussed later in this chapter.

5.2 Soxhlet Extraction and Experimental Setup

Soxhlet extraction is used as an analytical reference technique. The technique is done in a setup composed almost entirely of glassware. The solvent is added to a round bottom flask and is placed on a burner set to the boiling point of the solvent to allow for evaporation. The top of the solvent flask is connected to a glass extractor where the evaporated solvent can easily flow. Inside the extractor, the starting sample is usually contained within another, usually disposable, semi-permeable vessel called a thimble. The top of the extractor is connected to another piece of glassware where cooling water is allowed to flow constantly in order to cool the newly evaporated solvent and allow it to condense back. As the solvent condenses, it falls on the starting material in the thimble within the extractor and extracts soluble components. Once the condensate reaches a certain level, it is refluxed out of the extractor back into the solvent reservoir in the round bottom flask and the process is allowed to repeat for hours (usually between 6 to 48 hours) until all soluble components are extracted in the bulk of the solvent ³⁶.

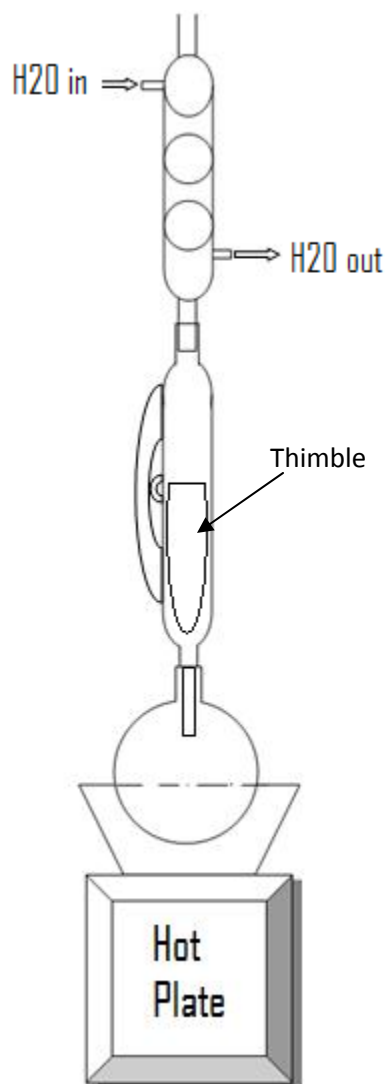

Figure 7: Soxhlet Extraction Setup

The soxhlet extraction setup used is shown in Figure 7. The setup operates based on total reflux and is comprised from the bottom up of a hotplate and different pieces of glassware that help with the extraction process. The solvent which is ethanol for this case is placed in the round bottom flask and the berry powder is carefully placed in the thimble which is then placed in the extractor. Finally the cooling water enters the top portion of the setup as indicated in Figure 7 in order to allow for the ethanol to condense and help with the reflux process. The detailed experimental conditions and procedures are described later in this chapter.

5.3 Equipment Specifications

5.3.1 Extraction and Collection Vessels

The extraction cell used is a Thar Designs model 26526-44. It has a 100ml volume and an operating pressure of up to 10,000 psi. The cell is constricted at the top and the bottom by two filters with a 5 micron pore diameter to ensure that no starting solids are transferred to the collection cell.

The collection vessel used is a Thar Designs model CL1573 with a 200ml capacity that operates up to pressures reaching 1,500 psi.

5.3.2 Temperature Controllers

The heater used to bring the system to temperature is an Ecoline chiller; it is made by Lauda and is designed to operate between -30°C and 90°C.²⁵

A PolyScience chiller is used to cool the CO₂ pump head. It is designed to operate at temperatures between -60°C and 30°C when ethylene glycol is used as the cooling fluid.³⁷

5.3.3 Wet Test Meter

A Precision wet test meter model 63135 was used to measure the amount of CO₂ leaving the system. The instrument operates at a pressure range between 0.3 and 0.6 in H₂O with an accuracy of ±0.5%.³⁹

5.3.4 Gas Chromatograph & Mass Spectrometer

A Varian CP-3800 gas chromatograph was used to analyze the samples. The GC was coupled with a mass spectrometer from Saturn, model 2000.

5.4 Experimental Procedures

5.4.1 Before an Experiment

Before initiating a run, both the extraction and the collection vessels are thoroughly cleaned and dried. The top and bottom screw pieces of the extraction vessel are checked to ensure that the filters are secured in place. After inspection, the bottom piece is screwed on tightly. The desired amount of powder, usually about 5 grams, is obtained from the chemical fridge and weighed carefully in a beaker. The contents of the beaker are then transferred carefully to ensure minimal loss of sample to the extraction vessel. Then, the screw top of the extraction vessel is secured tightly. The connections of the extraction vessel are then tightened connecting it to the back pressure regulator and to the coil where the solvent mix enters from the bottom. The collection vessel is then connected to the back pressure regulators and all the corresponding connections are tightened. Finally, more DI water is added to the beaker for the depressurizing step. The cover of the box is then put and fastened with tape to ensure no heat losses during an experimental run.

5.4.2 Preparing the Equipment

The equipment is prepared before a run by setting the first timer of the cooling bath on and ensuring it is at the desired temperature to cool the pump head for the CO₂. Then, the second timer is set to the desired times and connected to the heating bath; the heating bath is double checked to ensure proper temperature is attained. Then, the fan is plugged in to ensure proper air distribution and ensure that the entire insulated box is at the desired temperature. The temperature is recorded every ten minutes for thirty minutes to ensure that there are no major temperature fluctuations. Finally the flow meter is checked to ensure the reservoir has an

adequate amount of DI water; if the water level is too low in the reservoir or in the meter tube, then more water is added before the experimental run.

5.4.3 Beginning an Experiment

The CO₂ flow meter is turned on and the necessary gas information is inputted. The HPLC pump is turned on and left for a few seconds to do the embedded self-checks; and a quick check is done to verify there's enough ethanol in the reservoir. Meanwhile the CO₂ pump is turned on and also left to do the embedded self-checks. The box temperature is verified one final time before initiating the experiment. Then the depressurizing connections are retightened on the N₂ tanks for safety before opening the tanks. Both N₂ tanks 1 and 2 are opened and the desired pressures are set using the twist knobs on the tanks. The system is left for a few minutes to ensure the desired pressures are attained at the extraction and collection vessels. The pressures at the two back pressure regulators is checked to ensure it matches that of the N₂ tank pressures and recorded. To start the experimental run, the valve is opened so that all the flow goes to the system. The flow in the HPLC pump is set to 15ml/ min for about ten seconds to build pressure and to allow the ethanol to fill the lines; then the flow rate is decreased to the desired flow that accounts for about ten molar percent of the CO₂ used. The HPLC pump's starting pressure is recorded. Next the bi directional valve is set to the desired system on the high pressure pump and the CO₂ tank is opened. The pump valve is opened and the flow is set using the associated controller by selecting F2 and then option E and finally inputting a high flow rate (usually about 15 g/min) in order to rapidly build pressure in the system. Once the desired pressure is attained, the CO₂ flow rate is decreased to the desired flow rate by inputting it into the controller following the previously noted procedure. The final pressure of the CO₂ pump is recorded as the starting pressure of the experiment.

At this point, a second pressure reading is observed and recorded at the HPLC pump to verify that the pump pressure is now similar to the CO₂ pump's pressure to ensure proper flow of the co-solvent. Once both pump pressures are at the desired value, the gas flow meter is initiated to record the flow; both the starting time and starting gas volume are recorded. A typical run lasts approximately three to four hours; the temperature, CO₂ pump pressure, HPLC pump pressure and gas volume are all recorded every half hour during an experimental run to verify that no leaks have developed and that pressure is constant.

5.4.4 Shut Down Procedure

After a run is complete the two N₂ tanks are tightly closed and the shut down time is recorded. The flow rate is stopped in the CO₂ pump and the CO₂ tank is closed tightly. The gas flow meter is also stopped and the final gas volume and temperature is recorded. The HPLC pump is stopped by decreasing the flow rate to zero. The heating bath is turned off by switching it off or by turning off the associated timer and the fan is unplugged. The controlled environment's cover is opened to allow the vessels to cool down so the final product can be collected. Slowly, both the depressurizing connections on the N₂ tanks are loosened to allow for the slow release of pressure (takes up to 1.5 hours). Heating tape is wrapped around the back pressure regulators and turned on to ensure that the system does not develop any plugs. Once the pressure reaches zero, the heating tape is unplugged and left to cool off.

Both the CO₂ pump pressure and the HPLC pump pressure are observed to ensure that the pump heads have been fully depressurized. Once the pumps' pressures are noted to be zero, both pumps are turned off. The connections to the extraction and collection vessels are slowly loosened to ensure any trapped pressure is slowly released. The extracted material which is a liquid at this stage due to the ethanol presence is taken out of the collection vessel using a

pipette or clean syringe and put into a pre-weighed vial and wrapped with foil due to the photosensitive nature of some of the extracted compounds to ensure minimal degradation to these compounds during the collection process. The vial is then capped, weighed, labeled and immediately placed in the chemical's fridge so as to ensure minimal degradation of any sensitive compounds. The starting material is taken out of the extraction vessel and placed in a pre weighed vial and then reweighed and the weight is recorded. The beaker is then placed in the oven for two days to ensure any remaining ethanol is evaporated from the left over material and then the contents of the beaker are weighed a third time.

5.4.5 Cleaning Procedure

A medium sized beaker is filled with ethanol or isopropanol where the extraction vessel's filters are dropped in the beaker and stirred slightly to loosen any particles on the surface. Once the filters are cleaned, they are taken out of the beaker and are left to air dry. The extraction and collection vessels are immersed in water and washed thoroughly to ensure complete cleanliness. As an insurance step of cleanliness, a few ml of ethanol are placed in the vessels and swirled for several minutes. The vessels are then drained and left to air dry. Finally the filters are placed back into the extraction vessel and prepared for a new run. The lines are cleaned by attaching the extraction and collection vessels to the system and running pure CO₂ and ethanol at a high pressure for a minimum of 45 minutes.

5.4.6 Soxhlet Extraction Procedure

The glassware is checked to ensure that it is clean and dry before initiating an experiment. The desired amount of powder is weighed, about 10 grams and is placed into a clean thimble to prevent any powder from refluxing with the extract during an experiment. The thimble is then placed in the soxhlet extractor. In a clean round bottom flask, 300 ml of ethanol

are added and the extractor is placed on the round bottom flask. The flask is then placed in a hot water bath over a hot plate. A continuous cold water bath is attached to the top of the soxhlet extractor to help with the condensation process. The extraction process is done for twenty four hours at the boiling point of ethanol.

5.4.7 Soxhlet Extraction Cleaning Procedure

At the end of the experimental run, the glassware is carefully disassembled. The thimble is taken out of the extractor and the leftover material is carefully scrubbed out. The extractor and the round bottom flask are immersed in warm water and rinsed out several times to ensure that no material is left behind. The glassware is then left to air dry completely before another experiment can be initiated.

Chapter 6

Results and Discussion

This chapter will discuss the results obtained using the setups and procedures previously described in this work. Each sample was analyzed using a gas chromatograph coupled with a mass spectrometer. Results obtained from each experiment along with the experimental conditions will be reported and the corresponding GC obtained will be included. A discussion of all the findings will be discussed in greater detail at the end of the chapter.

For the supercritical experiments, in order to ensure that the entering CO₂-ethanol mixture was at the supercritical phase, the Peng-Robinson equation of state was used with the help of van der Waals mixing rules using the operating conditions for each experimental run for verification. Blueberry (BB) experiments were done using 8 and 12 ml/min of CO₂ with a steady 10 molar percent of ethanol. Operating conditions varied from 122 bars to 197 bars at temperatures ranging from 41.7 to 46.8 °C. Experiments were done in a 3 hour period. Cranberry (CB) experiments were done using a CO₂ flow rate of 12ml/min with a 10 molar percent of ethanol as a co-solvent. Operating conditions for the CB experiments were done at temperatures ranging from 46.7 to 50.4 °C and pressures of 122 to 194 bars. In addition soxhlet extractions were done at the boiling point of ethanol for 24 hours on both the blueberry and cranberry powders to determine the differences in the extract.

6.1 Results

Blueberry extracts obtained using the supercritical solvent mixture resulted in many important active components as outlined in Table 5:

Table 5: Blueberry Experimental Conditions and Corresponding Extract

Blueberry Experimental Conditions				
Pressure (Bars)	Temperature (°C)	CO ₂ flow rate (ml/min)	Extract	Extract GC peak time (min)
125	41.7	12	Vitamin A Vitamin B ₈ β-carotene	13.5 78.5 10.4
124	43.3	8	Vitamin A β-carotene	20 46
126	45.1	12	Decanoic Acid Pentanoic Acid Vitamin A	10.5 10.7 13.4
127	45.4	12	Retinol β-carotene	13.3 20
125	46.9	12	Biotin	64
197	46.8	12	Vitamin A Undecanoic Acid Ricinoleic Acid	10.3 30.6 74

Through supercritical extraction, the most prevalent active component extracted from the blueberries was vitamin A; it was extracted at four different temperatures and pressures. Vitamin A had strong peaks on the chromatographs that indicated that it was present in significant quantities at experimental conditions of 125 bars with a temperature of 41.7 °C, 124 bars with a temperature of 43.3 °C, at 126 bars with a temperature of 45.1 °C and finally at 197 bars and 46.8°C. The corresponding chromatographs are included later on in this chapter.

Experiments were also done on cranberry powder yielded in the extraction of many active ingredients using the supercritical fluid. Among the active ingredients extracted were important acids such as benzoic, and oleic acid. Benzoic acid which is present in cranberries in large quantities according to published works⁶¹, was extracted at three separate experimental

conditions at pressures of 125 bars and 48.3 °C, at 123 bars and 49.9 °C and finally at 125 bars coupled with a temperatures of 46.7 °C. A breakdown of the extracts obtained as a result of temperature and pressure along with resulting peak times are included in Table 6.

Table 6: Cranberry Experimental Conditions and Corresponding Extract

Cranberry Experimental Conditions				
Pressure (Bars)	Temperature (°C)	CO ₂ flow rate (ml/min)	Extract	Extract GC peak time (min)
125	46.7	12	Benzoic acid Vitamin A β-carotene	3.6 18 18.5
122	48.8	12	Oleic Acid Octadecanoic acid Vitamin A Retinol	8.2 12.5 17.4 18.6
125	48.3	12	Benzoic Acid Undecanoic acid Ricinoleic acid Vitamin A	3.7 10.6 18.1 19
123	49.9	12	Benzoic acid β-carotene	16.5 20
194	50.4	12	β-carotene	44

Soxhlet extractions were done for a period of twenty four hours at the boiling point of ethanol on both blueberry and cranberry powders resulted in some comparable extracts. Similarly to the supercritical extractions done, vitamin A, β-carotene, and Biotin were also extracted from the initial blueberry powder via soxhlet extraction. In addition, there was a small presence of Palmitic acid which only appeared in the soxhlet extraction done. The soxhlet extraction done on cranberry powder yielded only ricinoleic acid and undecanoic acid in quantities significant enough to be detected by the GC/MS, no other active components were detected as outlined in Table 7.

Table 7: Blueberry and Cranberry Soxhlet Extraction Experimental Conditions and Results

Blueberry Soxhlet Experimental Conditions					
Pressure (Bars)	Temperature (°C)	Solvent	Time (Hr)	Extract	Extract GC peak time (min)
1	78.9	Ethanol	24	Vitamin A β-carotene Palmitic Acid Biotin	3.8 18 28-32 71
Cranberry Soxhlet Experimental Conditions					
Pressure (Bars)	Temperature (°C)	Solvent	Time (Hr)	Extract	Extract GC peak time (min)
1	78.9	Ethanol	24	Ricinoleic acid Undecanoic acid	20 21

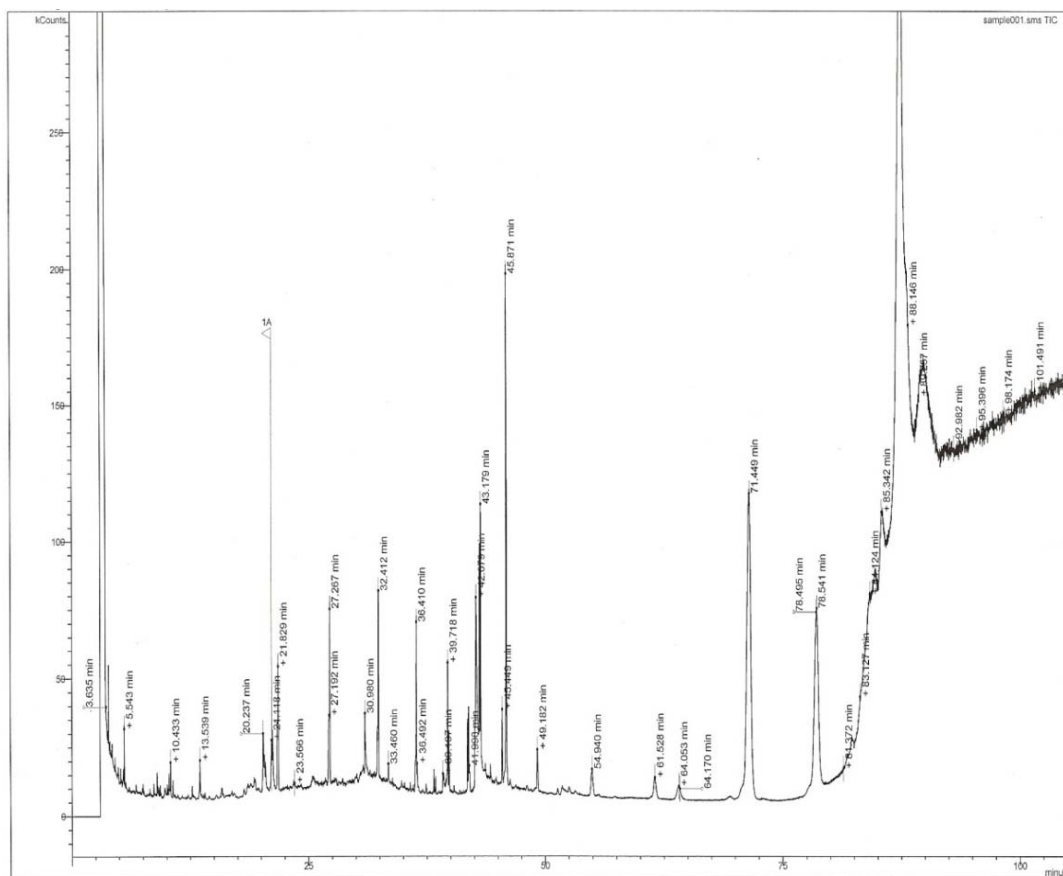

Figure 8: GC of BB Sample at 125 Bars and 41.7°C

The GC of a sample done using a higher flow rate of CO₂ of about 12 ml/min done at a pressure of 125 bars and a temperature of 41.7 °C is shown in Figure 8. The chromatograph contains lots of noise that may be attributed to several different factors. It may be due to impurities left in the column from different analyses that were not completely vaporized and thus are showing up as noise peaks on the chromatograph. The column may have also contained residual water from other samples. There were several important findings still in this chromatograph. Vitamin A was strongly present at the 13.5 minute mark. At the 78.5 minute mark, the chromatograph showed a significant presence of Biotin which is also sometimes referred to as vitamin B₈ or vitamin H. β-carotene was also moderately present around the 10.4 minute mark. Other minor peaks are contributed to pesticides and insecticides that were in the original starting material.

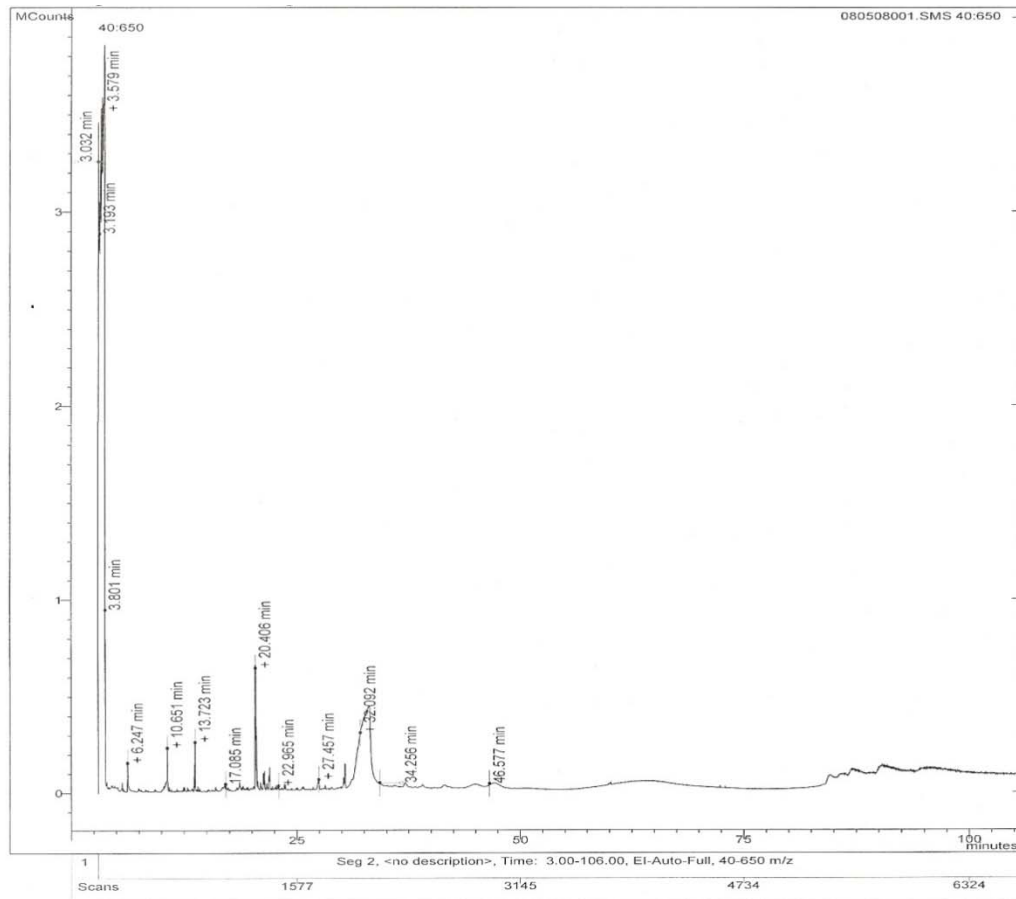

Figure 9: GC of BB Sample at 124 Bars and 43.3°C

Two important components were extracted as shown in Figure 9 which is a gas chromatograph of the results obtained from an experiment done using a CO₂ flow rate of 8 ml/min at operating conditions of 124 bars and 43.3°C. The most significant findings in this chromatograph were reflected in two distinct peaks. At approximately 20 minutes, there is a strong peak that shows the presence of vitamin A. There also was a noticeable presence of β-carotene around the 46 minute mark. The significance and uses of vitamin A and β-carotene are discussed in greater detail later on in this chapter.

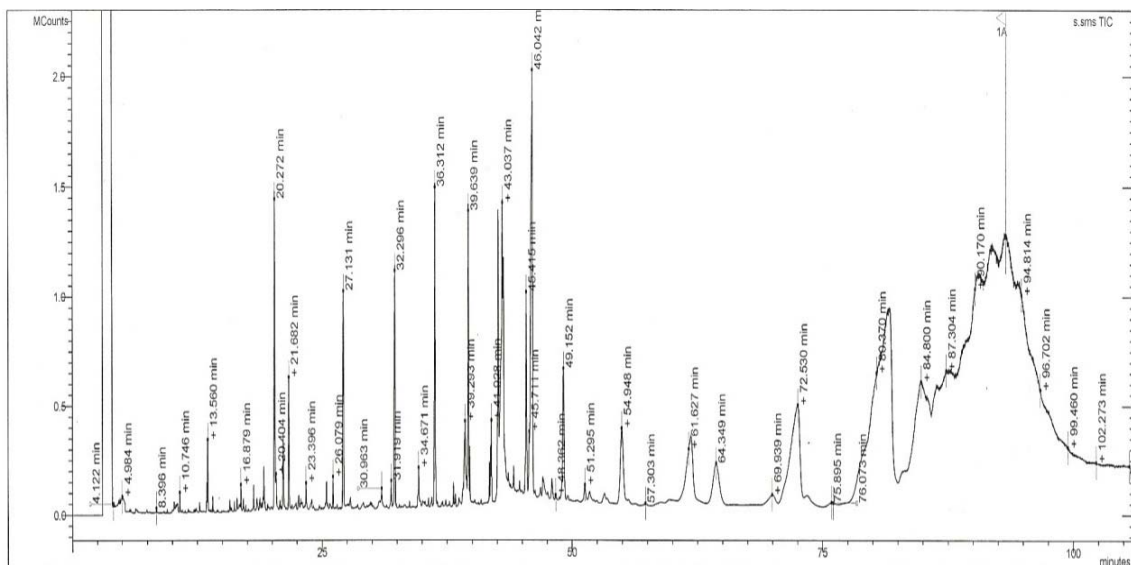

Figure 10: GC of BB Sample at 126 Bars and 45.1°C

At operating conditions of 126 bars and 45.1°C, Figure 10 shows a GC of the corresponding findings. The chromatograph contains some noise that can be attributed to poor injecting into the column or residual impurities left over from previous samples. In addition, pesticides and insecticides were present in the extracted material that contributed to some of the peaks on the chromatograph. Only a few active compounds were present in significant enough concentrations to be detected. Early on at the 5 minute mark, retinol was detected. The uses and significance of retinol is discussed in detail later on in this chapter. Decanoic acid was present in the sample and showed up on the chromatograph along with pentanoic acid around the 10.5 peak. Both acids are flavor compounds and are commonly used as food additives ⁸. Finally, vitamin A was strongly present as seen by a strong peak at the 13.4 minute mark which closely resembles previous findings.

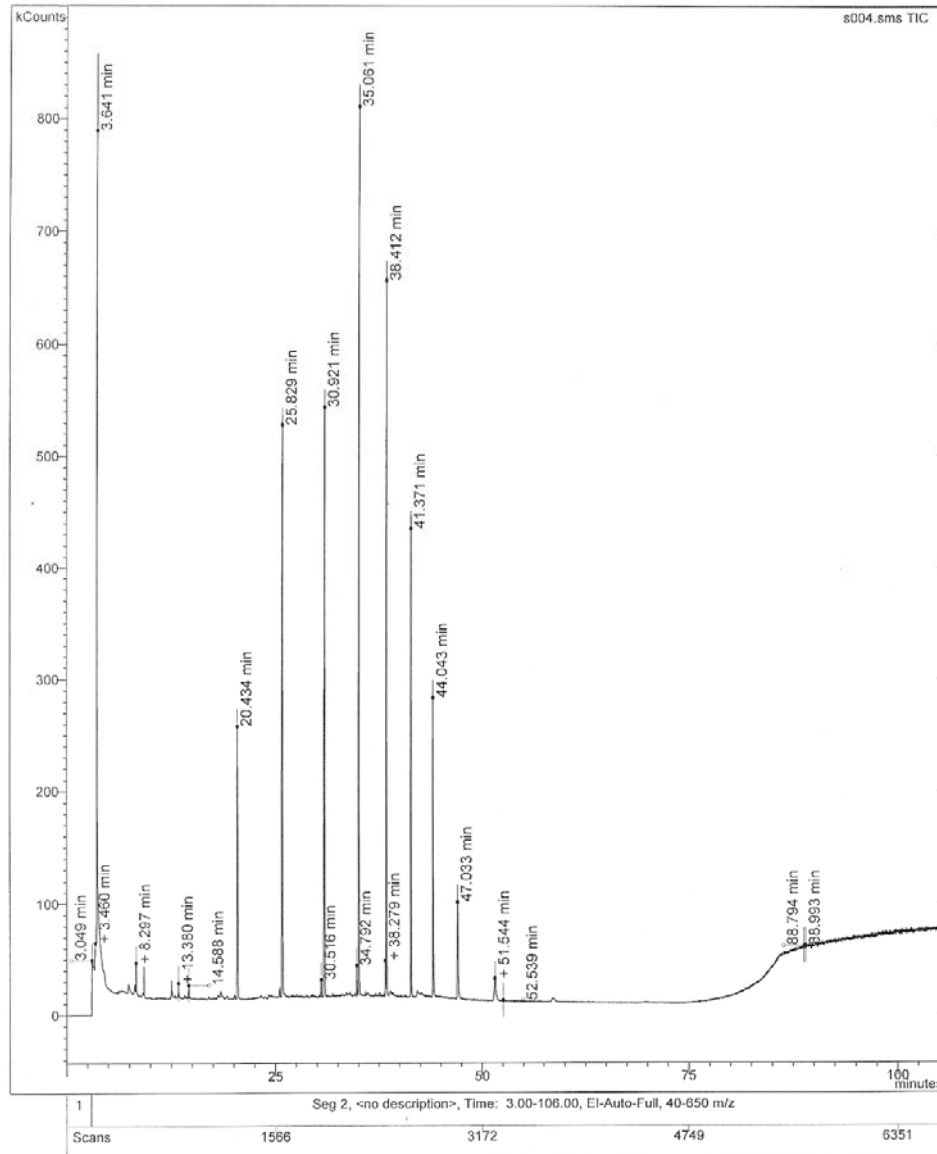

Figure 11: GC of BB Sample at 127 Bars and 45.4°C

GC of the extract obtained from blueberry powder at a pressure of 127 bars and a temperature of 45.4°C is shown in Figure 11. Although the figure seems to have many sharp peaks, those peaks are consistent with ethanol. The only identified compounds were retinol around 13.3 minutes which is shown by a small peak and β -carotene around 20 minutes.

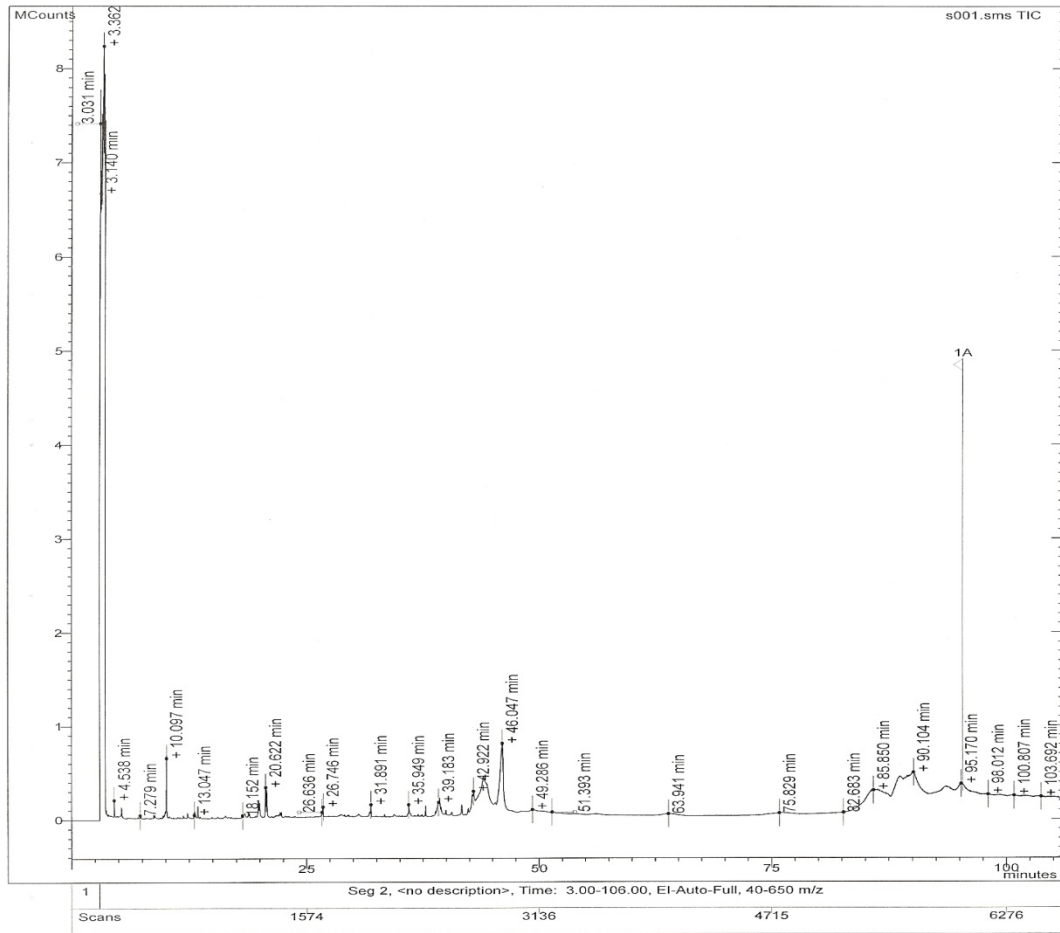

Figure 12: GC of BB Sample at 125 Bars and 46.9°C

The experimental conditions for the GC shown in Figure 12 were 125 bars and a temperature of 46.9°C with a CO₂ flow rate of 12 ml/min. There is minimal amount of noise in GC shown although some still exists. Only one significant finding was visible in this GC, around the 64th minute Biotin was detected. Other peaks were the result of trace amounts of pesticides and insecticides in the starting material.

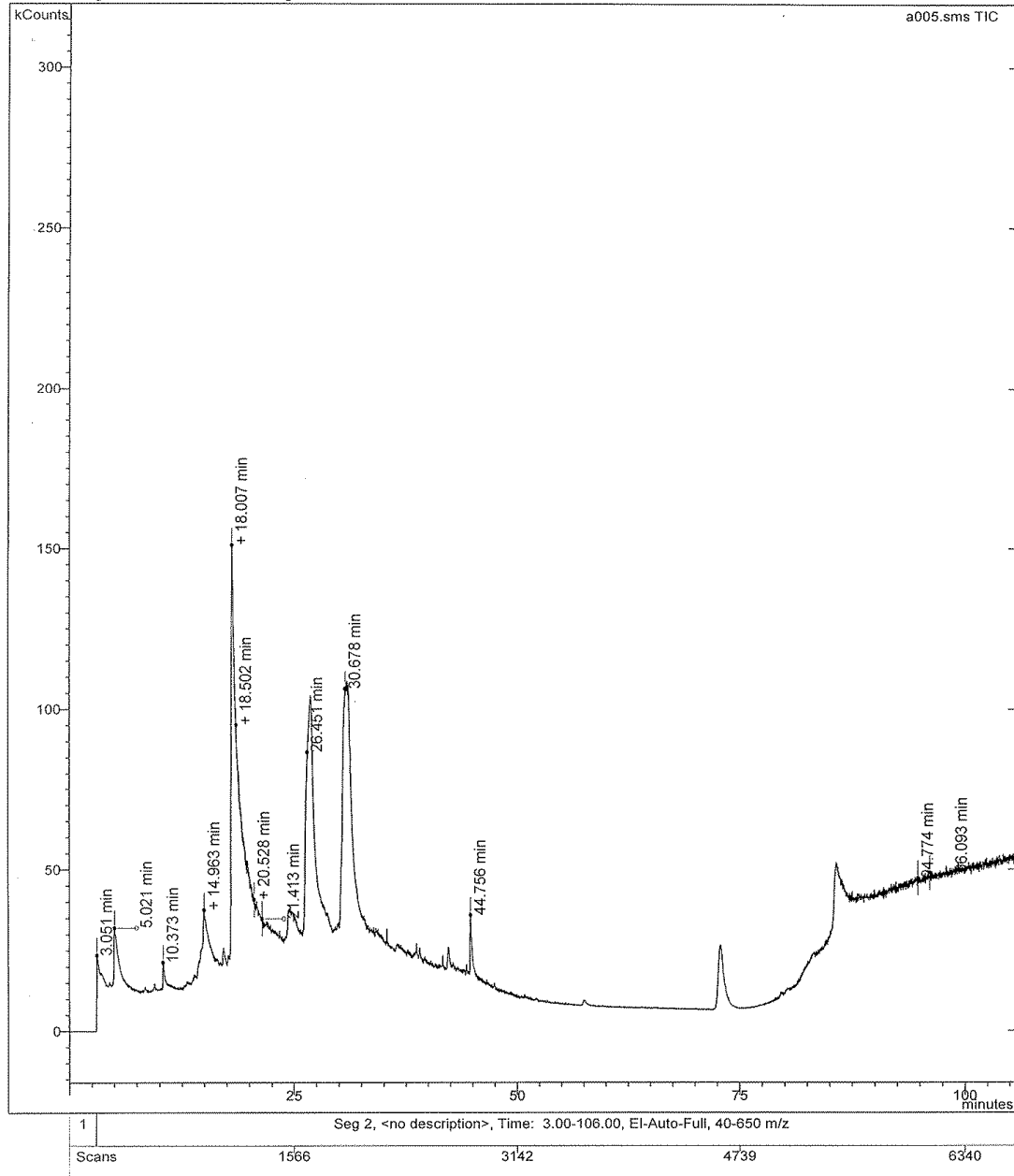

Figure 13: GC of BB Sample at 197 Bars and 46.8°C

The experimental conditions for the GC shown in Figure 13 included a pressure of 197 bars and a temperature of 46.8°C with a CO₂ flow rate of 12 ml/min. Vitamin A was detected at 10.3 minute peak, undecanoic acid was detected around the 30.6 minute peak and finally ricinoleic acid was detected around 74 minutes as indicated by a small yet defined peak. Some pesticides were also present in the extract.

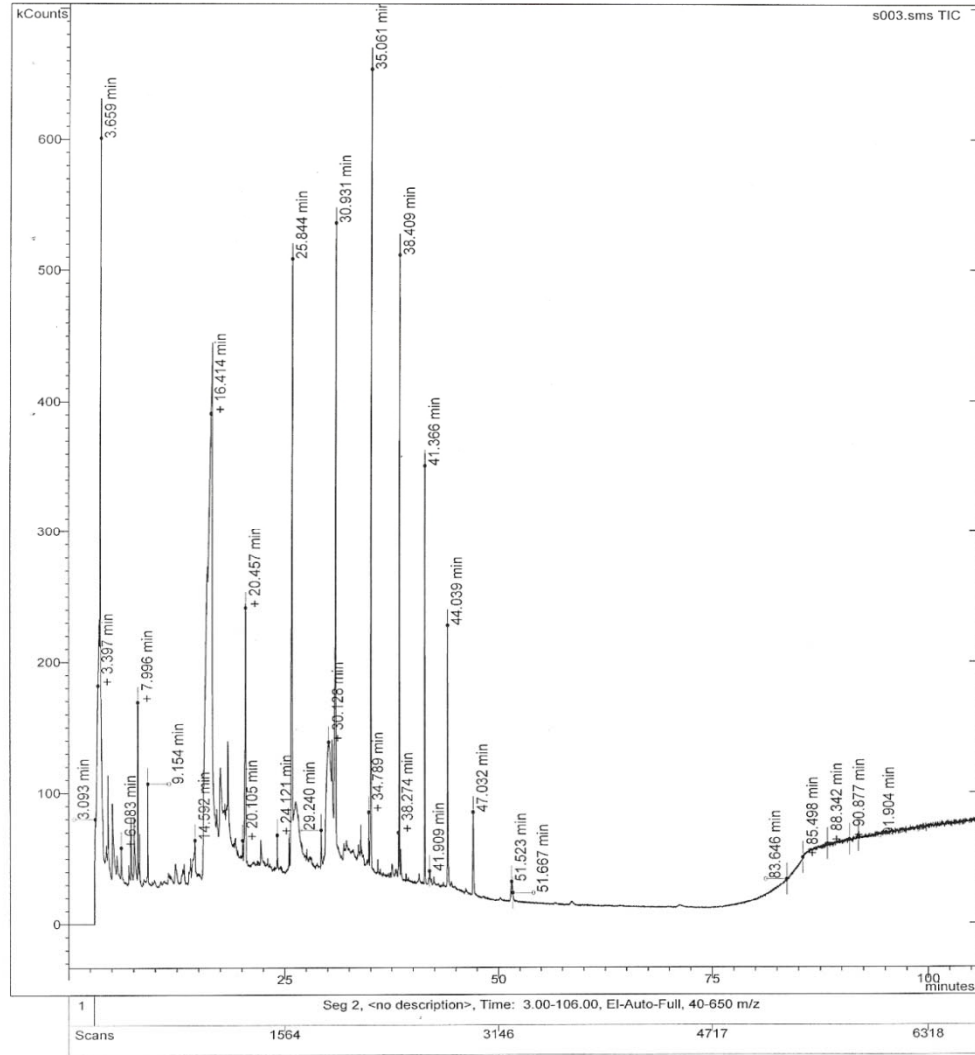

Figure 14: GC of CB Sample at 125 Bars and 46.7°C

The GC in Figure 14 shows the results obtained for cranberry extract under operating conditions of 125 bars and 46.7°C with a flow rate of 12 ml/min for CO₂. It can be seen from the figure that some noise is present and the detection of ethanol is also very evident; however three important compounds were identified. Benzoic acid showed a very strong presence as can be seen from the peak around 3.6 minutes. Vitamin A was identified around the 18th minute mark. And β-carotene was also present at around 18.5 minutes. Other minor peaks were the result of the presence of germination agents and pesticides.

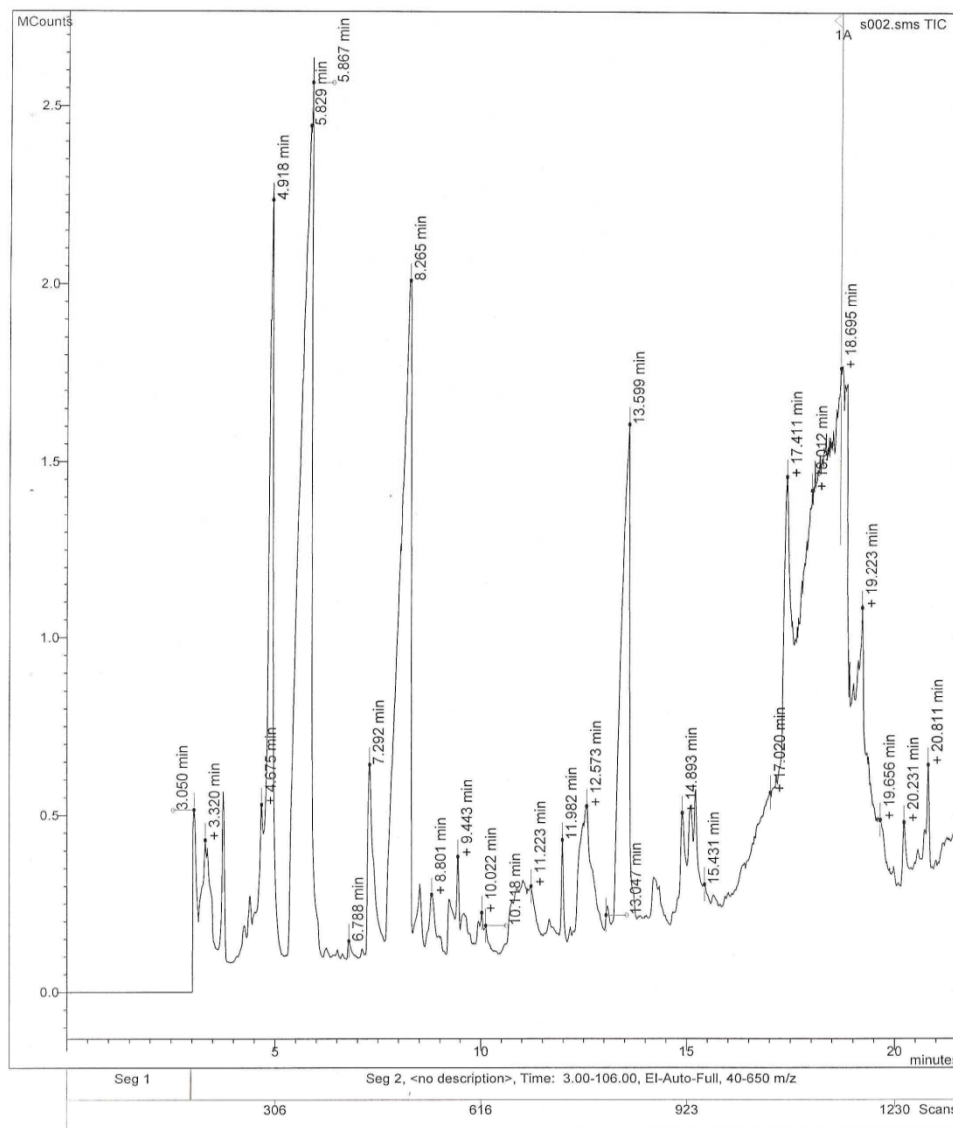

Figure 15: GC of CB Sample at 122 Bars and 46.8°C

At a flow rate of 12 ml/min for CO₂ with a pressure of 122 bars and a temperature of 46.8°C, Figure 15 shows the GC where several important compounds were identified. Although the previous chromatograph shows many peaks, only a handful of those peaks proved useful. Oleic acid which is an omega-9 acid was strongly present at 8.2 minutes into the run. Octadecanoic acid which is another omega-9 acid was identified to have a peak around 12.5 minutes. Vitamin A was present at 17.4 minutes and retinol had a strong peak at 18.6 minutes.

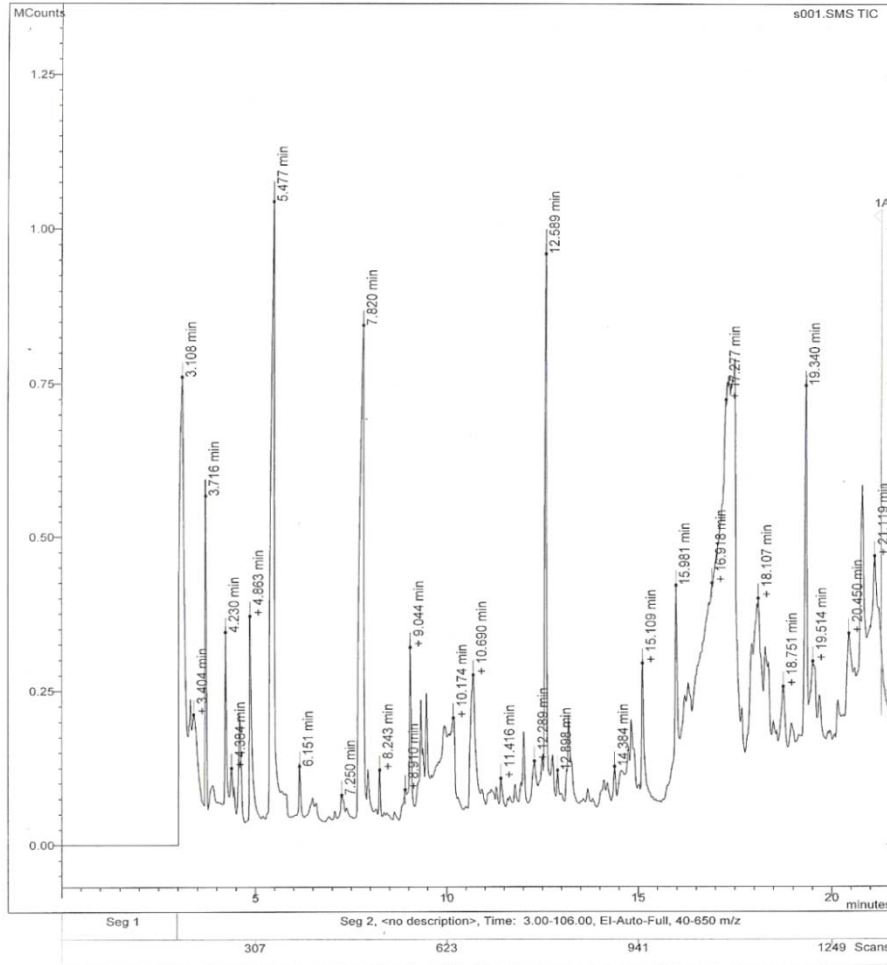

Figure 16: GC of CB Sample at 125 Bars and 48.3°C

Several important compounds were extracted and identified using a CO₂ flow rate of 12 ml/min and a pressure of 125 bars with a corresponding temperature of 48.3°C as shown in Figure 16. Benzoic acid was strongly present as shown by the peak around 3.7 minutes. Undecanoic acid was also identified by the peak visible around 10.6 minutes. In addition, ricinoleic acid which is an omega-9 fatty acid was present around the 18.1 minute peak. Finally vitamin A was noticeably present around the 19 minute mark. The importance and uses for the identified components will be included later in the discussion portion of this chapter.

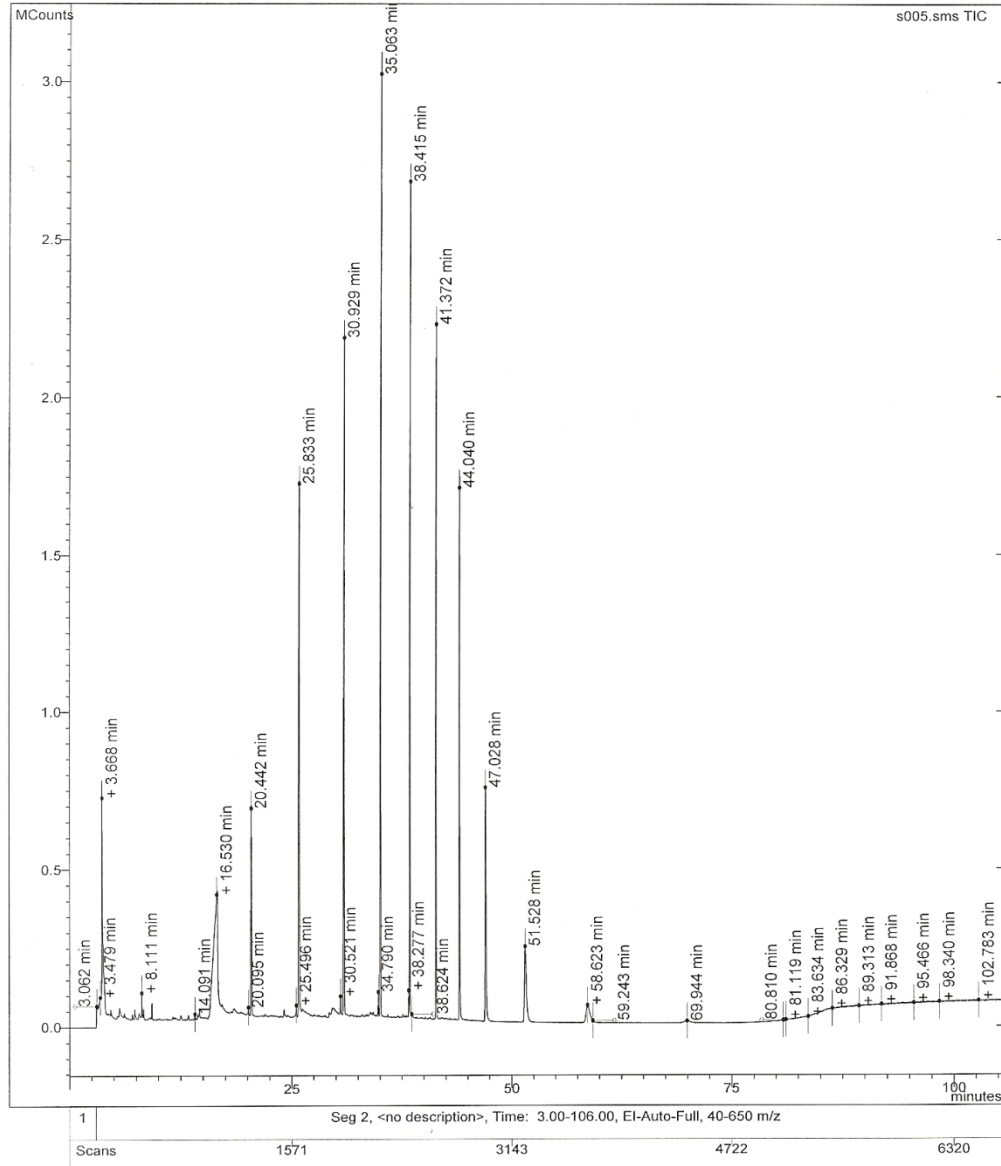

Figure 17: GC of CB Sample at 123 Bars and 49.9°C

Results obtained from an experiment done at a pressure of 123 bars and a corresponding temperature of 49.9 °C with a CO₂ flow rate of 12 ml/min are shown as Figure 17. Ethanol is strongly detected by well defined peaks along with some germination agents and pesticides. Benzoic acid was identified around the 16.5 minute peak. β-carotene was present around the 20 minute mark. The uses and importance of the active compounds will be included later on in this chapter under the discussion section.

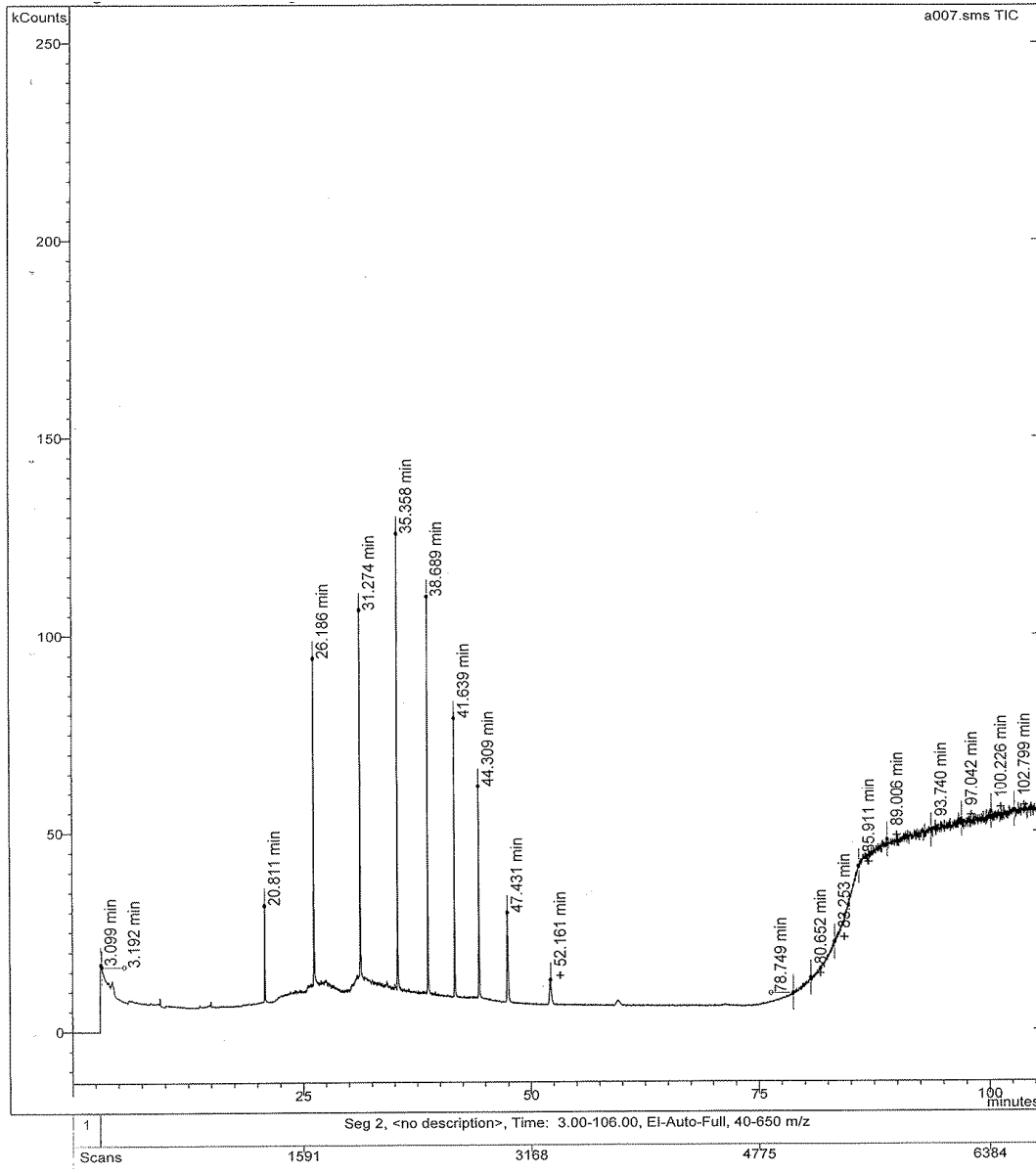

Figure 18: GC of CB Sample at 194 Bars and 50.4°C

Extract was obtained from cranberries under a pressure of 194 bars and a temperature of 50.4°C with a CO₂ flow rate of 12 ml/min as shown in Figure 18. The only active ingredient that was present in a large enough quantity to be detected at 44 minutes was β-carotene. Other peaks were attributed to the presence of ethanol and pesticides from the starting berry powder.

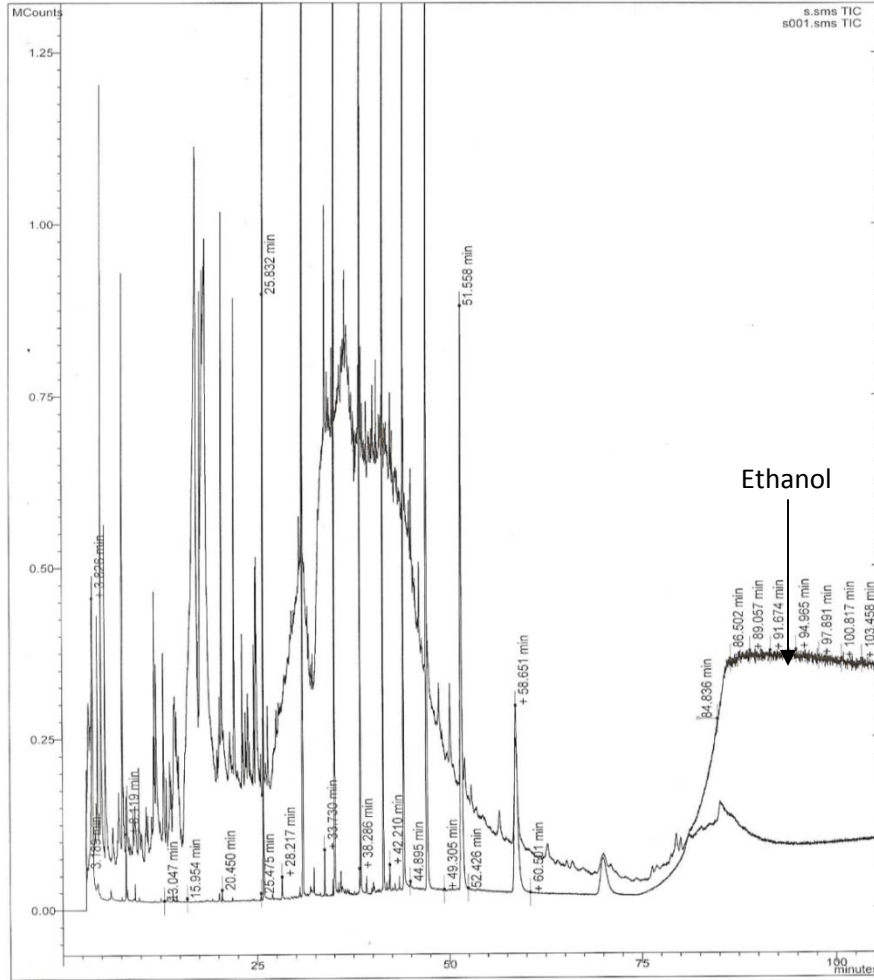

Figure 19: GC of CB Sample by Soxhlet Extraction with an Ethanol Baseline

The chromatograph of components extracted from cranberry powder using soxhlet extraction is shown in Figure 19. The extraction was done using ethanol and lasted for 24 hours. In the chromatograph, two distinct plots are shown. The first one is of the ethanol baseline as indicated on the graph and the second is of the sample. It can be seen that both lines overlap a great deal which suggests that only a few compounds were extracted under this method. Only ricinoleic acid and undecanoic acid were present in large enough quantities to be detected. Both active components showed up around the 20 to 21 minute mark. Other peaks were of pesticides that are soluble in organic solvents and were thus extracted with the ethanol. Pesticides extracted are outlined in Table 8.

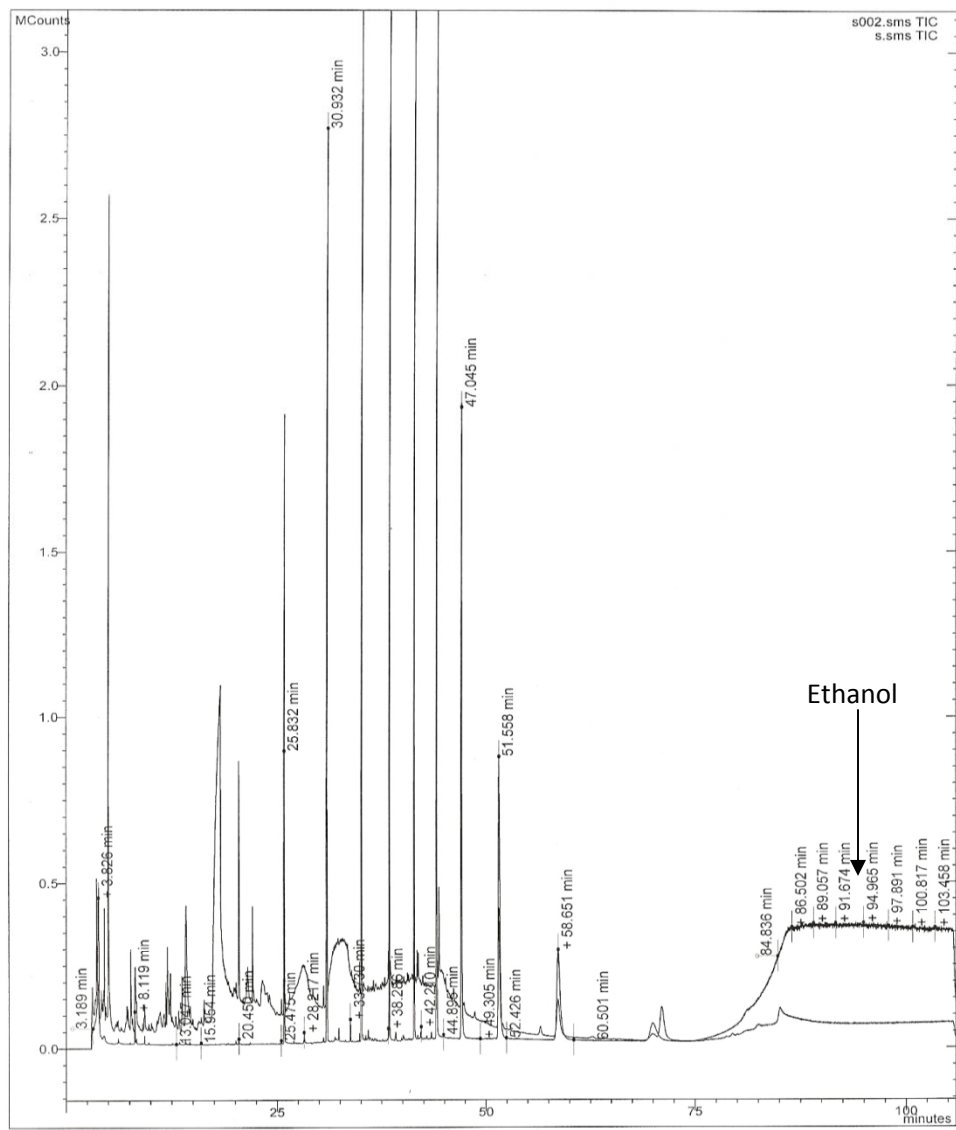

Figure 20: GC of BB sample by Soxhlet Extraction with an Ethanol Baseline

Soxhlet extraction was done for 24 hours on blueberries using ethanol as the solvent. The GC shown in Figure 20 includes the ethanol baseline as indicated by the arrow, as well as the plot from the sample. Both plots largely overlap. Active ingredients detected included vitamin A, β -carotene, palmitic acid and biotin. Vitamin A was identified at the peak shown around 3.8 minutes. In addition β -carotene was present around the 18 minute mark. Palmitic acid was present in the peak between 28 and 32 minutes. Finally, biotin was present in a minor peak around 71 minutes.

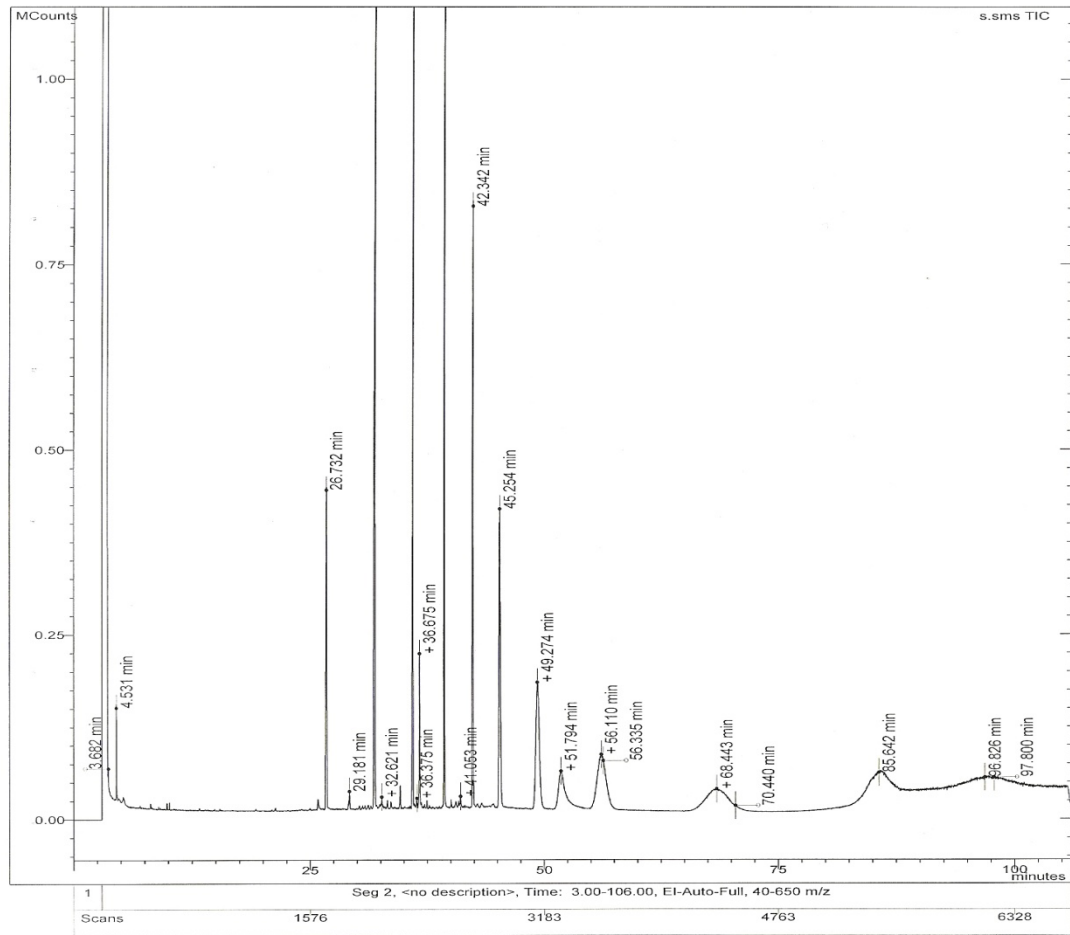

Figure 21: GC of Ethanol

The GC of ethanol which was used for all the samples as the standard is shown as Figure

21.

6.2 Discussion

As shown from the included chromatographs, many desirable active components were extracted under the different temperatures and pressure used for the experiments. In addition, residuals of pesticides, insecticides and germination agents were also extracted and are shown in Table 8. Some active components such as vitamin A and β -carotene were extracted under more than one of the operating conditions used which suggests that they are easier to extract than other components present in the starting powders at chosen operating conditions. The extracted components included several important acids such as oleic acid, ricinoleic acid, benzoic acid, stearic acid, palmitic acid and undecanoic acid. The advantages of the vitamins and acids extracted and their uses will be discussed in greater detail in the following section.

Vitamin A and its precursors are some of the most useful and powerful vitamins that are essential for many processes in the human body. In both the blueberry and cranberry experiments, vitamin A and some of its precursors were successfully extracted as previously noted. Research is constantly uncovering new various advantages to vitamin A in the human body. Vitamin A is essential from the fetal developmental stage up until adulthood. In the developmental stage, vitamin A aids epithelial cells to differentiate and continues this process through adulthood⁵. Epithelial cells and tissue are responsible for a variety of life functions including protecting sub surfaces of the body from abrasions and various injuries; secreting hormones and enzymes from glands, aiding in the absorption process of nutrients and various components from different organs such as the kidney and the lumen and even aid in sensations such as taste, vision and hearing¹⁶. So in reality, vitamin A is partially the underlying cause for all these important bodily functions mentioned previously because a deficiency in vitamin A

translates to poor epithelial proliferation and thus negatively affects all the aforementioned functions.

Carotenoids such as β -carotene, shown in Figure 22 are stored in the body for various functions. Part of the β -carotene is left in its current state and is used by the body for its antioxidant properties. A small portion is converted to retinoic acid. A second part of the absorbed β -carotene is converted to retinol as mentioned before in order to give rise to vitamin A⁵.

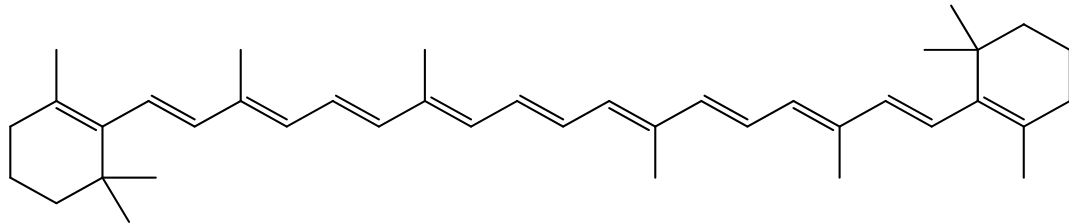

Figure 22: β -Carotene Molecule

Research is showing a strong correlation between vitamin A, its precursors and chances of reducing the development of certain cancers such as lung, colon, prostate and breast cancers⁵. This evidence stems from the fact that retinoids are responsible for regulating cell proliferation in the body as previously discussed and cancer is a disease of abnormal cell

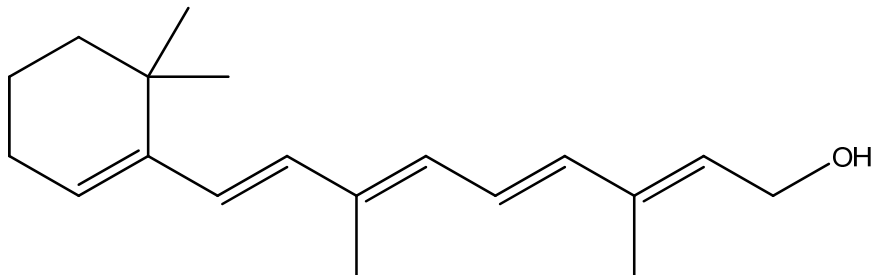

Figure 23: Retinol Molecule

proliferation. Hence, the theory that a deficiency in retinoids such as retinol, shown in Figure 23, may increase the chances of abnormal cell differentiation and thus development of carcinogenesis came to exist. Further studies are being conducted to back up this theory which has great potential if proven correctly. It is recommended that diets contain at least 600 to 1500 µg of retinoids on a daily basis; however this recommendation is only based on the idea that retinoids aid in the development of vitamin A, if the previously mentioned idea is proved, the recommended daily intake of retinoids will most likely be increased significantly.⁵

In addition to their role in cell proliferation, retinoids such as retinol have been linked to other uses in the body such as maintaining vision, aiding the immune system and proper functionality of the reproductive organs. Retinoids have been shown to have an important role in the proliferation of progenitor cells that affect the immune system.⁵

In the female reproductive system, retinol helps to eliminate placental necrosis where the tissue simply dies and is fatal to the developing fetus as all nutrients are cut-off. Retinol also eliminates the chances of developing a fetal resorption condition where the embryo dies and pregnancy components are resorbed⁵. In males, retinol is essential in the maintenance of spermatogenesis which ultimately gives rise to spermatozoa¹⁶.

Vitamin A deficiency causes severe complications such as blindness, xerophthalmia and even mortality as the body becomes more prone to catching diseases such as measles⁵. Premature births and newborns with very low birth weights (VLBW) have also been linked to a deficiency of vitamin A as the correct amount of vitamin A buildup is not reached for premature births and those who are deficient have poorly proliferated cells and thus are more likely to have VLBW. VLBW children are more likely to have ill-developed organs and have a higher risk of developing disease later on in life.⁵

It is estimated that over 100 million children are affected by vitamin A deficiency and are potentially at risk of death as a result ⁵. Using supercritical fluids to extract essential precursors of the vitamin is an effective and inexpensive way that can be used to turn the active compounds into supplements at an affordable cost in hopes of eliminating this deficiency which has the potential to save lives due to all the previously mentioned advantages and essentiality of the vitamin and its precursors for the body.

Benzoic acid was also identified in the cranberry experiments conducted in the later part of this work. According to a study by Yuegang et al ⁶¹, cranberries contain an ample amount of benzoic antioxidants that include o-hydroxybenzoic acid, 2,3-dihydroxybenzoic acid and benzoic acid; shown below in Figure 24.

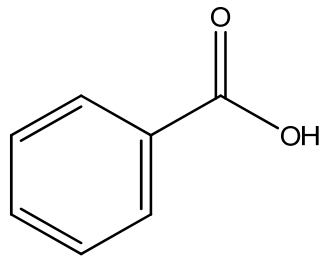

Figure 24: Benzoic Acid Molecule

It is estimated that benzoic and phenolic antioxidants are present in quantities as much as 5.7g/Kg of cranberries; a value that surpasses many other fruits and vegetable. Although, still in its infancy, some studies suggest that benzoic antioxidants may have anti carcinogenic and anti microbial effects in vitro. In addition, benzoic acid is a commonly used food preservative.⁶¹

Among the other important acids extracted and identified is ricinoleic acid which is an omega-9 fatty acid that is present mainly in castor and in many berry plants. Similar to many other berry components, the health benefits associated with ricinoleic acid are not well

documented. In a study conducted by Vieira et al ⁵³; it was shown that the acid can have very important medicinal properties. It was identified that ricinoleic acid, shown below, has great anti-inflammatory properties when applied locally at the site of inflammation.

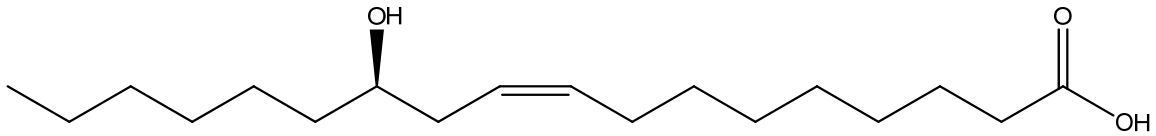

Figure 25: Ricinoleic Acid Molecule

In addition, it was shown that the acid did not cause any adverse hyperalgesic effects even with heat or chemical subjection. This suggests that it may prove to be superior to other, common anti-inflammatory agents currently used. Due to the perceived lack of adverse side effects associated with ricinoleic acid, it may also be used as an analgesic. Studies also suggest that the acid may possess laxative properties if it enters the gastrointestinal tract.⁵³

Stearic Acid which was present in several cranberry samples in this work is a saturated fatty acid that is also known as octadecanoic acid. Stearic acid has a very unique quality in that unlike other fatty acids, stearic acid acts to lower LDL cholesterol levels in the body.⁹

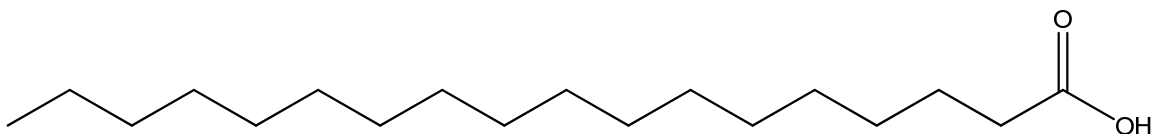

Figure 26: Stearic Acid Molecule

The human body has two types of cholesterol, LDL and HDL. LDL cholesterol is what is typically being referred to when someone is diagnosed with high cholesterol levels. Abnormally high LDL levels can cause artery blockage which can be a serious health risk as it can lead to

clotting and strokes. Therefore the role that stearic acid may play in lowering LDL levels can be very important.⁹

Oleic Acid, shown below, was extracted under the experimental pressures and temperatures used in this work as previously noted. Oleic acid is a mono saturated fat that possesses useful qualities. It can be used as a healthier substitute for saturated fat as it can reduce the body's risk of developing sudden cardiac death (SCD). Studies have also shown that oleic acid can prevent lipoproteins in the body from oxidizing and consumption does not increase the risk of primary cardiac arrest like other fats.³⁵

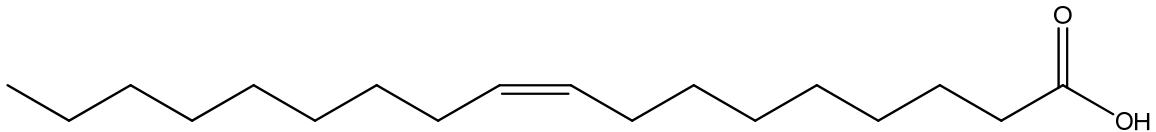

Figure 27: Oleic Acid Molecule

Compounds were extracted from the initial solid powders using a supercritical CO₂-ethanol mixture. Some components such as benzoic acid, biotin, β-carotene, ricinoleic acid and vitamin A were also extracted with the soxhlet extraction. Meanwhile, some acids were only extracted via the supercritical mixture such as stearic and oleic acids. While both methods were successful in extracting some components, using supercritical CO₂ proved to be a superior method of extraction. Moderate changes in temperature and pressure changed some of the components extracted as shown from the GC results which can be a very helpful tool in selecting only the desired components from the starting material. However, changes in temperature proved to have a greater effect on the materials extracted as was evident from the experimental trends. Moderate changes in temperature significantly changed the outcome of the extracts

while maintaining the temperature and changing the pressure proved to have a minimal positive effect on increasing the selectivity of the extracted components.

There are many disadvantages to using the soxhlet extraction technique, first selectivity of components extracted is limited by many factors, among which is the solubility of components in the solvent at the boiling temperature. In addition, experimental time is greatly increased; soxhlet extractions were done over 24 hours versus the typical 3 hour experiments done with supercritical fluid extractions. With supercritical fluid extraction, an increase in pressure can eliminate the use of a co-solvent and the CO₂ leaves the system as a gas, rendering a solvent-free sample. Also, cost can be minimized by recycling the supercritical fluid back into the system. Whereas in soxhlet extractions, the solvent is saturated with the extract and must be separated and discarded before the extracted material can be used. This adds an extra step which can be very costly on an industrial scale.

In addition to the active ingredients extracted from the berries, many pesticides and insecticides were also extracted as outlined in Table 8:

Table 8: Pesticides and Insecticides Extracted²²

Name	Use
Gibberelic Acid	Germination
Quinoline	Pesticide precursor
Isoquinoline	Insecticide
Imazalil: (1H-imidazole1-methyl)	Fungicide
Furfural	Fumigant: pesticide
Methotrexate	Insecticide
Strychnine	Pesticide
Cholesteryl: (Cholest-5-en-3-ol)	Inert pesticide ingredient

Supercritical fluids can be an inexpensive and safe alternative for extracting useful components from solid starting materials. Although, it was shown that moderate temperature

and pressure changes can have a big effect on the components extracted; changes in temperature seemed to have a greater effect on the components extracted. However when dealing with natural products, selection of temperature is a key factor, higher temperatures can degrade some of the desired active components.

It has been shown that supercritical fluids can be used for selective extraction of desired components. In addition, it has been shown that supercritical fluids can be used as a means of extracting potentially harmful pesticides and insecticides from plant and natural components.

Chapter 7

Conclusions, Recommendations and Future Directions

This chapter will include all relevant conclusions to this work. In addition it will provide several recommendations and improvements on the current setup and experimental conditions. And finally it will propose additions that can be done in the future to maximize results.

7.1 Conclusions

The experiments conducted yielded several important vitamins and acids that are useful for human health as previously discussed in the results section of this thesis. However there were other compounds such as pesticides and insecticides extracted in the process as well. The extraction of such potentially harmful components is another application for supercritical fluids. The Supercritical technology can also be used to extract undesirable compounds in order to purify important foods and desirable products from pesticides and insecticides. This allows for better, healthful berries in this case that can be safely used to devise vitamins and medications with a low cost margin attached.

7.2 Recommendations and Future Directions

At the moderately high pressures used in the experiments conducted, only some components of the berries were extracted. It is recommended that much higher pressures be used in order to extract more components. Pressures that are double and even triple those used

for this work will surely improve the results by potentially extracting heavier vitamins and minerals present in the berries and may eliminate the use of a co-solvent.

To maximize on the time for each experiment, it is recommended that more than one collection vessel be connected to the system. This will allow for more than one sample to be collected from each individual run. Each collection vessel can also be maintained at a different pressure so that several samples at several different pressures are obtained from one experiment.

A slightly different experimental procedure can be utilized by soaking the solid starting material in the co-solvent or water for a couple of hours before allowing the supercritical fluid to flow. This may help to open the plant pores and thus help with the extraction process. In addition, different co-solvents can be tried to determine if different components can be extracted using different co-solvents.

Different components in samples obtained from each experiment can be analyzed using GC/MS but can also be isolated using an HPLC setup in the future as a stepping stone to finding the concentrations of the components present in each sample.

Obtaining various different component libraries for the GC/MS analysis can also be a crucial step in identifying a variety of components potentially extracted but can only be identified using certain chemical libraries.

Fractionation of extract is another step that can be done after the extraction either by using an HPLC setup or by changing operating conditions on the extraction setup by gradually increasing the pressure.

Experimental times can be increased to more than the maximum time limit that was used for this work along with increasing the flow rate of the CO₂ in hopes of extracting more compounds at the higher flow rates.

References

1. Abbas, K. A., A. Mohamed, A. S. Abdulmir, and H. A. Abas. "A Review of Supercritical Fluid Extraction as New Analytical Method." *American Journal of Biochemistry and Biotechnology* (2008): 345-53.
2. Abraham, Martin A., and Aydin K. Sunol. *Supercritical Fluids : Extraction and Pollution Prevention*. New York: American Chemical Society, 1998.
3. Arai, Y., T. Sakou, and Y. Takebayashi. *Supercritical Fluids : Molecular Interactions, Physical Properties and New Applications*. New York: Springer, 2001.
4. Balch, Phyllis A. *Prescription for Dietary Wellness : Using Foods to Heal*. New York: Avery, 2003.
5. Blomhoff, Rune. *Vitamin A in Health and Disease*. Danbury: Marcel Dekker Incorporated, 1994.
6. Brunner, Gerd. *Gas Extraction : An Introduction to Fundamentals of Supercritical Fluids and the Application to Separation Processes*. Dietrich Steinkopff, 1994.
7. Brunner, Gerd H. *Supercritical Fluids as Solvents and Reaction Media*. St. Louis: Elsevier Science, 2004.
8. C. Chandan, Ramesh, Yiu H. Hui, Stephanie Clark, Nanna Cross, Joannie C. Dobbs, William J. Hurst, Leo M. Nollet, Eyal Shimoni, Nirmal Sinha, and Erika B. Smith. *Handbook of Food Products Manufacturing: Health, Meat, Milk, Poultry, Seafood, and Vegetables*. Wiley-Interscience, 2007.
9. Chow, Ching K. *Fatty Acids in Foods and their Health Implications, Third Edition (Food Science and Technology)*. Null: CRC, 2007.
10. Clifford, Tony. *Fundamentals of supercritical fluids*. New York: Oxford UP, 1999.
11. Day, Chany-Yih, Chiehming J. Chang, and Chiu-Yang Chen. "Correction: Phase Equilibrium of Ethanol + CO₂ and Acetone + CO₂ at elevated pressures." *Journal of Chemical and Engineering Data* (1999): 365-65.
12. Day, Chany-Yih, Chiehming J. Chang, and Chiu-Yang Chen. "Phase Equilibrium of Ethanol + CO₂ and Acetone + CO₂ at elevated pressures." *Journal of Chemical and Engineering Data* (1996): 839-43.
13. Dean, John R., and S. Hitchen. *Applications of supercritical fluids in industrial analysis*. Springer Science & Business, 1993.

14. DeSimone, Joseph M., and William Tumas, eds. *Green Chemistry Using Liquid and Supercritical Carbon Dioxide (Green Chemistry Series)*. New York: Oxford UP, USA, 2003.
15. Ganguly, Jagannath, ed. *Biochemistry of Vitamin A*. New York: CRC P, 1989.
16. Gartner, Leslie P., and James L. Hiatt. *Color Textbook of Histology*. Philadelphia: Saunders, 2006.
17. Geankoplis, Christie John. *Transport Processes and Separation Process Principles (Includes Unit Operations)*. Upper Saddle River: Prentice Hall PTR, 2003.
18. Gupta, Ram B., and Jae-Jin Shim. *Solubility in Supercritical Carbon Dioxide*. Null: CRC, 2006.
19. Hamburger, M., D. Baumann, and S. Adler. "Supercritical Carbon Dioxide Extraction of Selected Medicinal Plants--Effects of High Pressure and Added Ethanol on Yield of Extracted Substances." *Phytochemical Analysis* 15 (2004): 46-54. Wiley InterScience.
20. Jacques, R. A., J. G. Santos, C. Dariva, J. Vladimir Oliveira, and E. B. Caramão. "GC/MS Characterization of Mate Tea Leaves Extracts Obtained From High-Pressure CO₂ Extraction." *Journal of Supercritical Fluids* (2007): 354-59.
21. Jung, Jennifer, and Michel Perrut. "Review: particle design using supercritical fluids: Literature and patent survey." *Journal of Supercritical Fluids* (2001): 179-219.
22. Kegley, S.E., Hill, B.R., Orme S., Choi A.H., *PAN Pesticide Database*, Pesticide Action Network, North America (San Francisco, CA, 2008), <http://www.pesticideinfo.org>.
23. 22King, Jerry W., and Gary R. List. *Supercritical fluid technology in oil and lipid chemistry*. Champaign, Ill: AOCS P, 1996.
24. 23Kiran, Erdogan, and Levelt Sengers. *Supercritical fluids fundamentals for application*. Dordrecht: Kluwer Academic, 1994.
25. Lauda Eco Line Manual. Brochure. Germany.
26. Leitner, Walter, and Philip G. Jessop. *Chemical synthesis using supercritical fluids*. Weinheim: Wiley-VCH, 1999.
27. Martinez, Jose L., ed. *Superficial Fluid Extraction of Nutraceuticals and Bioactive Compounds*. New York: C R C P LLC, 2007.
28. McHugh, Mark, and Val Krukonis. *Supercritical Fluid Extraction Principles and Practice*. Stoneham: Butterworth, 1986.
29. Méndez-Santiago, Janette, and Aryn S. Teja. "The Solubility of Solids in Supercritical Fluids." *Fluid Phase Equilibria* 158 (1999): 501-10.
30. Modell, Michael, and Jefferson W. Tester. *Thermodynamics and Its Applications*. Upper Saddle River: Prentice Hall, 1996.

31. Montañès, Fernando, Tiziana Fornari, Pedro J. Martín-Álvarez, Antonia Montilla, Nieves Corzo, Agustin Olano, and Elena Ibàñez. "Selective Fractionation of Disaccharide Mixtures by Supercritical CO₂ with Ethanol as Co-Solvent." *Journal of Supercritical Fluids* (2007): 61-67.
32. Mukhopadhyay, Mamata, and Sameer V. Dalvi. "New Prediction Method for Ternary Solid-Liquid-Vapor Equilibrium from Binary Data." *Journal of Chemical and Engineering Data* (2005): 1283-289.
33. Mukhopadhyay, Mamata. *Natural Extracts Using Supercritical Carbon Dioxide*. Null: CRC, 2000.
34. Nyvlt, Jaroslav. *Solid-Liquid Phase Equilibria*. St. Louis: Elsevier, 1977.
35. Perk, Joep, Peter Mathes, Helmut Gohlke, Catherine Monpere, and Irene Hellemans. *Cardiovascular Prevention and Rehabilitation*. New York: Springer, 2007.
36. Plattenberg, Rachel H. *Environmental Pollution : New Research*. New York: Nova Science, Incorporated, 2006.
37. PolyScience Digital Constant Temperature Circulators. Brochure. Illinois.
38. Prausnitz, John M., Edmundo Gomes De Azevedo, and Rudiger N. Lichtenthaler. *Molecular Thermodynamics of Fluid-Phase Equilibria*. Upper Saddle River: Prentice Hall PTR, 1998.
39. Precision Wet Test Meter. Brochure. Texas.
40. Prior, Ronald L., Sheryl A. Lazarus, Guohua Cao, Helen Muccitelli, and John F. Hammerstone. "Identification of Procyanidins and Anthocyanins in Blueberries and Cranberries (*Vaccinium* Spp.) Using High-Performance Liquid Chromatography/Mass Spectrometry." *Journal of Agriculture and Food Chemistry* (2008): 1270-276.
41. Ramsey, E. D. *Analytical supercritical fluid extraction techniques*. Springer, 1998.
42. Raspo, Isabelle, Christophe Nicolas, Evelyne Neau, and Sofiane Meradji. "Diffusion coefficients of solids in supercritical carbon dioxide: Modelling of near critical behaviour." *Fluid Phase Equilibria* (2008): 214-22.
43. Reverchon, Ernesto, and Iolanda De Marco. "Review: Supercritical Fluid Extraction and Fractionation of Natural Matter." *Journal of Supercritical Fluids* (2006): 146-66.
44. Rieger, Mark. *Introduction to Fruit Crops*. New York: Food Products P, 2006.
45. Siegel, Michael. *The Encyclopedia of New Jersey*. Ed. Maxine N. Lurie and Marc Mappen. New York: Rutgers UP, 2004.
46. Smith, J. M., Hendrick C. Van Ness, and Michael M. Abbott. *Introduction to Chemical Engineering Thermodynamics*. New York: McGraw-Hill Companies, The, 2004.

47. Subramaniam, Bala, Roger A. Rajewski, and Kirk Snavely. "Pharmaceutical Processing with supercritical Carbon Dioxide." *Journal of Pharmaceutical Sciences* 86 (1997): 885-90.
48. Sun, Ya-Ping. *Supercritical Fluid Technology in Materials Science and Engineering: Syntheses Properties, and Applications*. Null: CRC, 2002.
49. Sunol & Sunol in Wypych, George, ed. *Handbook of solvents*. Toronto: ChemTec, 2001.
50. United States. Department of Agriculture. *Blueberry Nutritional Data*. 19 Jan. 2009.
51. United States. Department of Agriculture. *Cranberry Nutritional Data*. 19 Jan. 2009.
52. Vatai, Tünde, Mojca Škerget, and Željko Knez. "Extraction of Phenolic Compounds from Elder Berry and Different Grape Marc Varieties Using Organic Solvents and / or Supercritical Carbon Dioxide." *Journal of Food Engineering* (2009): 246-54.
53. Vieira, Celme, Stefano Evangelista, Rocco Cirillo, Annalisa Lippi, Carlos A. Maggi, and Stefano Manzini. "Effect of ricinoleic acid in acute and subchronic experimental models of inflammation." *Mediators of Inflammation* 9 (2000): 223-28.
54. *Vitamin A Supplements : A Guide to Their Use in the Treatment and Prevention of Vitamin A Deficiency and Xerophthalmia*. Chicago: World Health Organization, 1997.
55. Von Rohr, Rudolf, and Ch Trepp. *High pressure chemical engineering proceedings of the 3rd International Symposium on High Pressure Chemical Engineering, Zurich, Switzerland, October 7-9, 1996*. Amsterdam: Elsevier, 1996.
56. Walas, Stanley M. *Phase Equilibria in Chemical Engineering*. London: Butterworths Tolley Limited, 1985.
57. Xu, Xiang, Yanxiang Gao, Guangmin Liu, Qi Wang, and Jian Zhao. "Optimization of supercritical carbon dioxide extraction of sea buckthorn (*Hippophaë thamnoides* L.) oil using response surface methodology." *LWT* (2008): 1223-231.
58. York, Peter, Uday B. Kompella, and Boris Y. Shekunov. *Supercritical Fluid Technology for Drug Product Development*. Danbury: Marcel Dekker Incorporated, 2004.
59. Yoshioka, M., and Simone Parvez. *Supercritical Fluid Chromatography And Micro-hplc (Progress in HPLC)*. New York: Brill Academic, 1989.
60. Zaidul, I. S., N. A. Nik Norulaini, A. K. Mohd Omar, and R. L. Smith Jr. "Supercritical Carbon Dioxide (SC-CO₂) Extraction and Fractionation of Palm Kernal Oil From Palm Kernal as Coca Butter Replacers Blend." *Journal of Food Engineering* (2006): 210-16.
61. Zuo, Yuegang, Chengxia Wang, and Jian Zhan. "Separation, Characterization, and Quantitation of Benzoic and Phenolic Antioxidants in American Cranberry Fruit by GC/MS." *Journal of Agricultural and Food Chemistry* (2002): 3789-794.

Appendices

Appendix A: Tables of BB and CB Nutritional Information

Table 9: Blueberry Key Nutrients

Blueberry Key Nutrients ^{4, 50}			
Element	g/100g (unless otherwise noted)	Element	g/100g (unless otherwise noted)
Water	54.66	Protein	0.41
Fiber	2.6	Sucrose/sugars	37.75
		Fructose	
		Glucose	
Vitamin C	0.7mg	Vitamin b1 (thiamine)	0.023mg
Folate	3mcg	Vitamin b2 (riboflavin)	0.034mg
Iron	0.8mg	Vitamin b3 (niacin)	0.091mg
Manganese	Na**	Pantothenic acid	Na**
Potassium	115mg	Biotin	0.029mg
Calcium	27mg	Vitamin E	0.23mg
		Alpha Tocopherols	
Magnesium	10mg	Silicon	Na**
Phosphorus	12mg	Fats/Lipids	0.2
Sodium	12mg	Carbohydrates	44.38
Zinc	0.1mg	Selenium	0.4mcg
Copper	0.112mg	Limonene	Na**
Alpha-carotene	Na**	Myristicin	Na**
Beta-carotene	13mcg	Thymol	Na**
Caryophyllene	Na**	Pectin	Na**
Chlorogenic acid	Na**	Catechins	Na**
Eugenol	Na**	Vitamin A, RAE	1mcg
Ellagic acid	Na**	Vitamin K	3.9mcg
Tocotrienols	Na**	Lutein + zeaxanthin	33mcg
Choline	3.8mg	Palmitic Acid	Na**

** Na refers to values that were unavailable at the time of data compilation

Appendix A: (CONTINUED)

Table 10: Cranberry Key Nutrients

Cranberry Key Nutrients ^{4, 51}			
Element	g/100g (unless otherwise noted)	Element	g/100g (unless otherwise noted)
Water	60.65	Citric acid	Na**
Energy	151	Protein	0.2
Carbohydrates	38.9	Fiber	1
Magnesium	3mg	Potassium	26mg
Fructose	37.9	Calcium	4mg
Sucrose			
Glucose			
Benzoic acid	Na**	Folate	3mcg
Ellagic acid	Na**	Eugenol	Na**
Manganese	Na**	Malic acid	Na**
Selenium	0.3mcg	Sodium	29mg
Phosphorus	6mg	Vitamin b1 (thiamine)	0.015mg
Chloine	3.8mg	Vitamin E/ tocopherols	0.83mg
Biotin	0.014mg	Ferulic acid	Na**
Chlorogenic acid	Na**	iron	0.22mg
Vitamin A, RAE	2mcg	Copper	0.02mg
Zinc	0.05mg	Vitamin b3 (niacin)	0.1mg
Vitamin b2 (riboflavin)	0.021mg	Beta-carotene	25mcg
Fats/Lipids	0.15	Oleic Acid (18:1)	0.021
Linoleic Acid (18:2)	0.04	Alpha Linoleic Acid	0.026
Palmitoleic Acid (16:1)	0.001	Palmitic Acid (16:0)	0.008
Quercetin	Na**	Vitamin C	2mg
Vitamin K	1.4 mcg	Lutein +zeaxanthin	63mcg
Pantothenic Acid	Na**	Ricinoleic Acid	Na**

**Na refers to values that were unavailable at the time of data compilation

Appendix B: Sample Calculations

The following sample calculations are done to ensure the solvent mixture used is above the critical point. This is done by using the peng-robinson equation of state coupled with van der Waals mixing rules.

Operating Parameters:

Pressure P=124 bar

Gas constant R=8.314 J/mol*K

Temperature T=315.928 K

Critical Temp (CO₂) T_c=304.3 K

Critical Pressure (CO₂) P_c=73.8 bar

Accentric factor (CO₂) ω=0.228

T_r=1.03812

Peng Robinson Equation of State

$$P = \frac{RT}{V-b} - \frac{a(T)*\alpha}{v^2+2bV-b^2}$$

$$a(T_c) = \frac{0.45724R^2T_c^2}{P_c} = \frac{0.45724*8.314^2*304.3^2}{73.8} = 39656.26$$

$$b(T_c) = \frac{0.07780RT_c}{P_c} = \frac{0.07780*8.314*304}{73.8} = 2.667$$

$$\begin{aligned}\alpha &= (1 + (0.37464 + 1.54226\omega - 0.26992\omega^2) * (1 - Tr^{0.5}))^2 \\ &= (1 + (0.37464 + 1.54226 * 0.228 - 0.26992 * 0.228^2) \\ &\quad * (1 - 1.03812^{0.5}))^2 = 0.9733\end{aligned}$$

$$A = \frac{a * \alpha * P}{R^2 * T^2} = \frac{39656.26 * 0.9733 * 124}{8.314^2 * 315.928^2} = 0.6937$$

$$B = \frac{b * P}{R * T} = \frac{2.667 * 124}{8.314 * 315.928} = 0.1259$$

$$z^3 - z^2 * (1 - B) + z * (A - 3B^2 - 2B) - (AB - B^2 - B^3) = 0; z = 0.32034$$

Appendix B: (CONTINUED)

Applying the mixing rules

Mole fraction CO₂ $y_i=0.9$

Mole fraction Ethanol $y_j=0.1$

$$a_{mix} = y_i^2 * a + y_j^2 a_{eOH} + 2 * y_i * y_j * a_{ij} = 47428.07$$

$$a_{ij} = (a * a_{eOH})^{0.5} = 76777.85$$

$$b_{mix} = y_i * b + y_j * b_{eOH} = 2.9637$$

$$A_{mix} = y_i * A + y_j * A_{eOH} + (2 * y_i * y_j * (A * A_{eOH}))^{0.5} = 1.1261$$

$$B_{mix} = y_i * B + y_j * B_{eOH} = 0.1399$$

$$z_{mix}^3 - z_{mix}^2 * (1 - B_{mix}) + z_{mix} * (A_{mix} - 3B_{mix}^2 - 2B_{mix}) - (A_{mix}B_{mix} - B_{mix}^2 - B_{mix}^3) = 0, z = 0.20736$$

Calculating Dimensionless Numbers

Calculating Reynold's number for CO₂ at a pressure of 2100 psia, a temperature of 40°C given a diameter $D= 7.36*10^{-4}$ m, CO₂ density $\rho= 780.4$ kg/m³, average fluid velocity $v= 0.47$ m/s and fluid viscosity $\mu= 67.74*10^{-6}$ kg.s/m.s².

$$N_{Re} = \frac{7.3 * 10^{-4} \text{ m} * 0.47 \frac{\text{m}}{\text{s}} * 780.4 \frac{\text{kg}}{\text{m}^3}}{67.74 * 10^{-6} \frac{\text{kg} \cdot \text{s}}{\text{m} \cdot \text{s}^2}} = 3988$$

Calculating the Prandtl number:

$$Pr = \frac{v}{\alpha} = \frac{cp * \mu}{k} = \frac{(67.74 * 10^{-6} \frac{\text{Kg}}{\text{m} * \text{s}}) * (267.52 \frac{\text{J}}{\text{Kg} * \text{s}})}{0.086057 \frac{\text{J}}{\text{m} * \text{s} * \text{K}}} = 0.210$$

Calculating the Nusselt number:

$$Nu = 2 + 0.6 * Re^{\frac{1}{2}} * Pr^{\frac{1}{3}} = 2 + 0.6 * 3988^{\frac{1}{2}} * 0.210^{\frac{1}{3}} = 24.52$$

Appendix B: (CONTINUED)

Calculating the Sherwood number:

$$S_h = \frac{K_c * \text{Diameter}}{D} = 2 + 0.6 * Re^{\frac{1}{2}} * Sc^{\frac{1}{3}} = S_h = 2 + 0.6 * 3988^{\frac{1}{2}} * 22.86^{\frac{1}{3}} = 109.54$$

Rearranging the Schmidt correlation and solving for D at the same conditions yields:

$$S_c = \frac{v}{D} = \frac{\mu}{\rho * D}$$

$$D = \left(\frac{22.86 * 780.4 \frac{\text{kg}}{\text{m}^3}}{67.74 * 10^{-6}} \right)^{-1} = 3.79 * 10^{-9} \frac{\text{m}^2}{\text{s}}$$

Now plugging back into the Sherwood equation and solving for the mass transfer coefficient K_c :

$$K_c = \frac{109.54 * (3.797 * 10^{-9} \frac{\text{m}^2}{\text{s}})}{0.043 \text{ m}} = 9.67 * 10^{-6} \frac{\text{m}}{\text{s}}$$

Appendix C: Simplified Procedure

A step by step simplified experimental procedure, shut down and cleaning methods used is provided as follows:

Before a run

Make sure all cells are clean and dry

Weigh desired amount of blueberries (~5g)

Load them carefully in extraction cell

Tighten all connections

Make sure water beaker has enough water for depressurizing step

Turning on the Equipment

Set Timer A: (Heating)- make sure heating bath's switch is turned ON and set to desired temp.

Set Timer B: (Cooling CO₂)- make sure cooling bath's switch is turned ON.

Plug fan in

Make sure flow meter has enough water in reservoir and in meter tube

Turn CO₂ flow meter ON.

Turn HPLC pump ON

Turn CO₂ pump ON

Verify box temp

Appendix C: (CONTINUED)

Verify depressurizing connections on N₂ tanks are tightened

Open N₂ tanks

Set to desired pressure

Wait a few minutes (check pressures inside controlled environment and record)

Verify there's enough ethanol in reservoir

Direct 3-way valve to the system

Ensure the tubing lines are filled with ethanol, if not, run ethanol for a few minutes

Set ethanol flow rate to desired flow (~0.02ml/min)

Note HPLC pump starting pressure

Open CO₂- tank

Direct 3-way valve to the system

Open pump valve

Select F2, Then E to set flow

Set Flow to 2G/min

Note starting pressure on CO₂ pump

Note the starting time of the experiment

Appendix C: (CONTINUED)

Once pressure begins to stabilize (about 1.5 hrs): (pressure of HPLC/ CO₂ pumps reaches set pressure on tank A)

Run CO₂ flow meter and hit next screen till run screen and hit Enter.

Note the starting time and starting gas Volume!!

After 2-4 hours: Shut down

Close back pressures (N₂ tanks)

Stop HPLC pump

Stop CO₂ pump

Close CO₂ tank

Stop CO₂ flow meter and note the final Volume and Gas Temp

Record the time of stopping

Turn off timer A (heating bath)

Open controlled environment's cover

Plug back pressure heating tape in to prevent freezing during depressurization

Slowly and carefully start depressurizing A & B

Observe to insure stable depressurizing (takes up to 1.5 hrs depending on the set pressure)

Unplug heating tape

Appendix C: (CONTINUED)

Loosen connections slowly on extraction cell and collection cell

Weigh two empty beakers and record weight

Collect starting material carefully in one beaker and weigh

Collect fraction carefully in another beaker or vial and weigh

Release any remaining CO₂ from fraction beaker (if it's fizzing, then there's CO₂)

Cap the extract and wrap it in foil (light sensitive)

Cleaning

Fill a beaker with isopropanol or ethanol

Drop filters in beaker (stir slightly)

Thoroughly wash extraction and collection cells with water

Check there's no residue remaining

Cap one end of extraction cell and run a few ml of ethanol in it

Air dry

Pump Pure CO₂ and ethanol in the lines for a minimum of 45 minutes to clean all the lines